

WESTERN SEAT / REINING SEAT  
WESTERN HORSEMANSHIP

AHA  
**EQUITATION**  
MANUAL

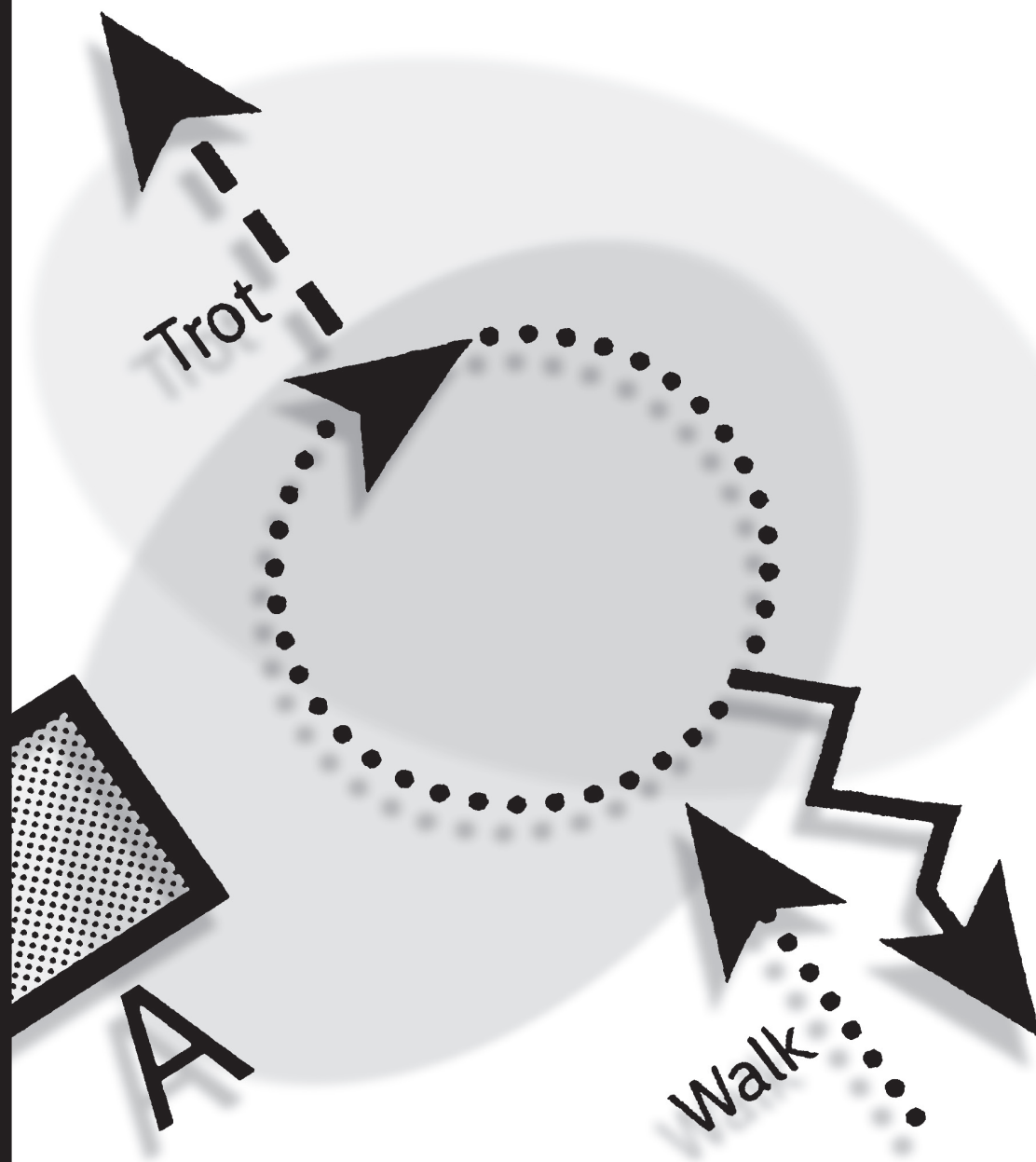

**Arabian Horse Association**  
6030 Greenwood Plaza Blvd, Suite 100  
Greenwood Village, CO, 80111  
303-696-4500  
ArabianHorses.org

**2024 EDITION  
REVISION 12.3**

# Thank You

Special thanks to the following people without whom the publication of this manual would not have been possible:

Michelle Pease-Paulsen, Chair  
Analise Himmel, Vice Chair

Kari Adamson	Bill Melendez
Darlene Barrett	LeAnne Moseley
Mary Jane Brown	Dawn Muschetto
Kathy Callahan-Smith	Frances Newsom
Mary Campbell	Sheri Odom
Lori Conway	Sarah Olmsted
Michael Damianos	Joan Palelek
Stacey Dunn	Michelle Pease-Paulsen
Analise Himmel	Debbie Price
Jim Hitt	Lorne Robertson
Cynthia Howey	Scott Scheyli
Deborah Johnson	Joyce Thomas
Juli Goder-Larson	Mariah Wilson
Jody LaSalle	Deb Witty
Ted Lange	Jodi Zeier

And extra thanks to Craig Christiansen and D. Hennington for use of their drawings.

©Copyright 2007, 2013–2024 by the Arabian Horse Association<sup>SM</sup>

All rights of this publication are reserved. Reproduction of this publication (except the pattern pages which are granted a limited, non-exclusive license for use by AHA Recognized Competitions) without prior written permission is strictly prohibited.

# Guidelines

## AHA EQUITATION MANUAL

This information has been compiled and endorsed by the AHA Equitation Committee in an effort to clarify many of the ambiguities that are currently present in the rules pertaining to the equitation divisions. It is not intended to be the final word on the subject, for any controversial statements with regard to equitation will almost certainly be met with disagreement. There may also be some areas that need addressing but were inadvertently omitted. Hopefully the benefits obtained by the use of this information will far outweigh any of its shortcomings. Items covered directly in either the *US Equestrian (USEF)* or the *Equestrian Canada (EC) Rule Books*, or the *Arabian Horse Association (AHA) Handbook* are not covered herein except for purposes of clarification.

Exhibitors should always know the rules of the pertinent association(s) and the classes in which they are competing. In the Arabian division, this means that the current *USEF/EC Rule Books* prevail, except where specifically modified by the current *AHA Handbook*. Copies of all rulebooks should be carried to horse shows, for easy reference. Any questions not readily answerable by consulting these rulebooks should be referred to this manual.

**Exhibitors should be aware the written directions of the pattern take precedence over the drawing. The drawings are a guide. In addition, the patterns are written to call for either correct/incorrect diagonals and leads or right/left diagonals and leads. In the patterns written utilizing right/left diagonals and leads, the word "right" has no inference as to whether the diagonal/lead is correct.**

Other questions should be addressed in writing and emailed to [info@ArabianHorses.org](mailto:info@ArabianHorses.org) or mailed to the Arabian Horse Association, 6030 Greenwood Plaza Blvd., Suite 100, Greenwood Village, CO, 80111 — Attention Judges & Stewards Commissioner. Canadian Shows are governed by the current Equestrian Canada rules. These can be obtained by writing or calling Equestrian Canada, 308 Legget Dr., Ste 100, Ottawa ON K2K 1Y6 (613-287-1515).

*Created and approved (BOD 1/91) Amended and approved (BOD 11/95)  
Revised 06/13*

*USEF rules require posting of patterns one hour prior to the class; however, the Equitation Committee recommends that copies of patterns be posted 24 hours in advance of the class and that copies of patterns be made available to all exhibitors. Regional and National Class patterns must be posted 24 hours in advance of the scheduled class.*

### **CONTENTS**

Guidelines.....	3
Do's & Don'ts.....	4-5
Guidelines – Tips for Judges .....	6
<b>Western Seat</b>	
Position of Rider.....	7-9
Attire of Rider/ Tack of Horse .....	10-11
<b>Reining Seat</b>	
Reining Seat Equitation....	12-13
Reining Seat Score Sheet .....	14
Patterns .....	15
<b>Western Horsemanship</b>	
Class Routine/ Patterns & Tests .....	16
Western Horsemanship Scoring, Credits & Faults .....	17-19
Patterns .....	20-75

# Do's & Don'ts

## Applies to Saddle Seat, Western Seat, Reining Seat, Western Horsemanship and Hunter Seat Classes

Be courteous at all times to fellow exhibitors, ring personnel, office workers, judges and the like. Sportsmanship is paramount in the field of equitation. Congratulate the winners. Your time will come some day and you would want the same courtesy extended to you. Also, be helpful to your fellow exhibitors. Point out, in a tactful manner, that their jod strap is undone or that their horse has slobbered on their chaps, etc.

Subtle verbal communication between rider and horse is encouraged in equitation classes; however, this communication should not be so loud as to be distracting to other exhibitors or ring personnel. A notable exception to this is when a rider is specifically addressing another rider, such as calling "rail." However, excessive yelling of "rail, rail" is very distracting and undignified and should be discouraged. The only time "rail" is appropriate is when another rider is cutting in dangerously close and collision is imminent. It is inappropriate for a rider to come up behind a rider already on the rail and force them off the rail. Riders should always be positioned so that they can go around those ahead of them on the inside (not the rail side), and should be penalized at the judge's discretion for not doing so.

Leave room in the lineup for the nervous horse or rider. In addition to being courteous and safety conscious, this will lessen the effect the other horse might have on your mount.

Show disciplined control of your mount, but never abuse it if it makes a mistake, either in the ring or after leaving the ring. The show arena and grounds are not proper places to "teach the horse a lesson." Emotions run high and a lot is at stake. Because of this, most mistakes are due to rider error for which the horse should not be punished.

Do not wear anything or put anything on the horse or rider that jiggles, flaps, or waves. This includes loose hair or hair ribbons, flapping ties or fringe and unpinned numbers. All of these are very distracting to the judge, especially not being able to read a rider's number. If a rider trims their number card, care should be taken to not reduce the size so that the judge can still easily read the number. Pinning numbers both top and bottom as well as from inside the shirt or jacket will make a smoother picture.

An exhibitor may wear protective headgear (ASTM/SEI or BSI/BS EN) and/or a protective safety vest, specifically designed for use in equestrian sport in any division or class without penalty from the judge. The federation recommends that the vest meet or surpass the current ASTM or BSI/BS EN standard or be certified by the Safety Equipment Institute.

Judges should appraise the ability and level of proficiency of the riders at the show before posting patterns. This can be accomplished by asking a member of show management. If

# Do's & Don'ts

they don't know the answer, they can easily find out by asking the steward to talk to the exhibitors. Both exhibitors and judges alike benefit from this little bit of advance planning. Those who want a challenge are given one, while those whose ability is not as advanced are given a test which they can perform, and the judge's decision is made simpler by this consistency. Judges should be prepared with more than one pattern for any given class so as to compensate for differences in the ability of the riders, ring sizes, weather conditions and the like. Judges should also be aware that in Reining Seat equitation, the 13 and Under riders are expected to be able to perform the same tests as the 14-18 riders — one of the current NRHA patterns.

Riders should enter the arena ready to show, displaying confidence and presence. Show that you are a rider and not just a passenger. Poise and consistency, even under adverse conditions, are necessary. Perfect the performance of your horse(s) to best reflect your equitation abilities. A ground-covering smooth walk should not be so strong that its lateral movement creates too much body motion in the rider. A smooth, cadenced jog or trot will be much more attractive than a bone-jarring concussive gait. Likewise, a smooth flowing canter or lope will enhance a rider's skill rather than the four-beat gait that shakes or vibrates the rider.

An exhibitor with a disability (other than hearing) will be provided reasonable accommodation upon submission of a written certification from a treating medical professional's office certifying the disability and identifying the accommodation necessary for the exhibitor to compete safely. The medical certification must be provided to the competition Steward within a reasonable time prior to competing, who shall then attach a copy to the Steward report.

# Guidelines

## TIPS FOR JUDGES

1. Get your patterns to show management so that they can be reviewed by the steward and posted at the proper time.
  - a. AHA Medal Classes — At least one hour prior to an AHA medal class.
  - b. Regional & National Equitation Classes — At least 24 hours prior to the first section of the eliminations.
  - c. National Shows — Subsequent patterns are to be available immediately following the last working section of each phase.
  - d. It is helpful to show management and exhibitors to receive patterns prior to the show so they may be copied for exhibitors and posted in a timely fashion.
2. Know the size of your arena, if you have a center ring box and where the entrance and exit gates are located before drawing your patterns.
3. Know which tests are allowed for each age group.
4. Make sure you are familiar with the AHA Equitation Manual and bring it to the show.
5. Review the Equitation section of the *USEF* or *EC Rulebook*, both in the General Equitation by seat and the Arabian Equitation Sections as well as the *AHA Handbook*. Bring Rulebooks, either electronic or hard copy, to the show.
6. Know the depth of the competition when choosing a pattern so that all riders can accomplish the pattern and the best riders will do it the best.
7. If the class is large, do not keep the riders in the lineup. It is **mandatory** at Regionals and Nationals to not have the lineup remain in the arena during patterns. This includes Saddle Seat, Hunter Seat not to jump, and Western Horsemanship classes.
8. Know your pattern and visualize it in the arena to know how it will play. Be aware of the position of the lineup compared to your pattern.
9. Prepare your card to reflect the proper percentages of rail/pattern work and be comfortable with the scoring system.
  - Saddleseat Equitation is 50 percent rail, 50 percent pattern
  - UPHA is 60 percent rail, 40 percent workout
  - Hunter/Jumper Seat equitation — not jump — is 50 percent rail, 50 percent pattern
  - Western Horsemanship is 50 percent rail, 50 percent pattern
10. Know if off-pattern is elimination or severe fault
  - Reining Seat is 100 percent pattern
  - Showmanship is 100 percent pattern
  - Saddleseat Equitation **is not** elimination
  - UPHA **is not** elimination
  - Hunter/Jumper Seat equitation — not jump — **is not** elimination
  - Western Horsemanship **is not** elimination
  - Reining Seat **is** elimination
  - Showmanship **is not** elimination
11. No cones or markers are to be used in pattern work for Saddle Seat classes.
12. The arena gate must be closed during railwork and patterns.
13. Patterns are not permitted in walk/trot or walk/jog Equitation.
14. All Hunter Seat Equitation Not to Jump patterns must exit and enter the arena at a walk.
15. Reward good horsemanship and showmanship.
16. Judges are not to confer individually with exhibitors, questions and answers are to be repeated and announced over the PA system.

### Show Committees Need to be Aware:

In AHA Medal Classes in which the required minimum number of entries is achieved, the fact that a contestant is excused from the arena once judging has commenced, or goes off pattern during the pattern portion of the class, will not nullify an AHA Medal Class win if the remaining number of exhibitors is less than the minimum requirement. In AHA Medal classes, points are accumulated so rail work and patterns are required, regardless of the number of exhibitors.

Medal winners may ride in any medal class throughout the year. Once a rider wins an AHA medal in a certain discipline, they will be allowed to show again in a medal class of the same discipline. All medal classes must be held for one or more exhibitors.

For walk/trot, walk/jog equitation information, review corresponding equitation seat in this manual and current *USEF/EC Rule Books*, Arabian Division.

# Western Seat/Reining Seat/ Western Horsemanship

## POSITION OF RIDER

1. **Legs and Feet:** Legs should hang naturally from the hip without being flared away from horse. Rider should not be penalized if the leg is slightly forward as a result of riding in a balanced position. Heels should be slightly lower than toes, and knees should face straight ahead. Heel position may vary depending on the type of stirrup used. Toes should also face straight ahead or turn slightly outward.
2. **Maintaining Center of Balance:** Rider should always be centered, not behind or in front of vertical. The rider's back should be flat with shoulders directly over hips. Rider should appear as one with the horse, not rigid or stiff which shows rider working against horse. The saddle should always be straight and the stirrups even. No daylight should ever be seen between seat and saddle or between legs and saddle. Proper and even weight should be placed in stirrups so that daylight cannot be seen between foot and stirrup. Any loss of stirrup is a major fault.
3. **Head:** Eyes should be looking directly forward through the horse's ears.
4. **Arms and Hands:** Upper arms are to be in a straight line with the body. Upper arms should be snug to the body, but not appear pinched. Rein arm should be bent at elbow showing a soft smooth line to hand. Shoulders should be kept square, neither tipped forward nor backward. If the romal side shoulder tends to dip or pull backward, it can be corrected by repositioning the romal hand. Hands should be quiet and soft and rider should not be constantly adjusting hand, do not let a large loop of rein develop above hand. Split and romal reins are equally acceptable. When split reins are used, the ends of split reins fall on the same side as reining hand and one finger between reins is permitted. When using romal or when ends of split reins are held in hand not used for reining, no finger between reins is allowed. The position of the hand not being used for reining is optional but it should be kept free of the horse and equipment and held in a relaxed manner with the rider's body straight at all times. The rider can hold romal or end of split reins to keep from swinging, and to adjust the position of the reins, provided it is held with at least 16 inches of rein between the hands. Hand to be above horn and as near to it as possible.
5. **Position in Motion:** Rider should sit to jog and not post. At the lope, rider should be close to the saddle. All movements of horse should be governed by the use of imperceptible aids and the shifting of rider's weight is not desirable.
6. **Extended Jog in Western Horsemanship only:** The rider should stay square and maintain proper overall body position yet animate their seat to encourage forward motion of the horse. The lower leg, while maintaining light contact and proper position may also become moderately more active to encourage the horse to lengthen its stride while maintaining cadence. The horse's stride should lengthen or extend not quicken.

**Extended Lope in Western Horsemanship only:** The rider should have a square balanced torso over a soft connected seat. The rider's seat may rhythmically drive the stride of the horse forward yet not interfere with the cadence of the gait. The horse should transition within a few strides from the lope to the extended lope, which is a lengthen stride not a quickened pace. The length of stride should not be any greater than is comfortable for the individual horse to carry and maintain.

Exhibitors are reminded to always refer to current *USEF/EC Rule Books* for specific rules regarding Western Seat/Reining Seat/Western Horsemanship position and suitability. Exhibitors are reminded to refer to the current *AHA Handbook* for procedures.

Refer to Current  
USEF/EC Rules  
(see diagrams)

# Western Seat/Reining Seat/ Western Horsemanship

## POSITION OF RIDER

**Fig. 1**

**CORRECT POSITION**

Square, balanced look, hair neat and number visible. Arms and legs give a soft controlled appearance.

**Fig. 2**

**INCORRECT POSITION**

Hat crooked with pigtails will give a floppy look. Shoulders are cocked with elbows in a pinched in position. Rider is trying to sit square on a crooked saddle with legs flared away from horse.

**Fig. 3**

**INCORRECT POSITION**

Rider's upper body is behind vertical with legs pushed forward to compensate. Rein hand is held next to horn with a thumb up look. Romal is looping forward instead of back. Free hand is held too far forward on leg creating a pinched look.

**Fig. 4**

**INCORRECT POSITION**

Rider's upper body is in front of vertical with hips tipped forward, creating a hollow-backed look. Because of hip position, legs are pulled back severely with heels elevated. Rein hand is dropped low in front of horn in a tipped forward position. Free arm is cocked back with an extreme elbow bend.

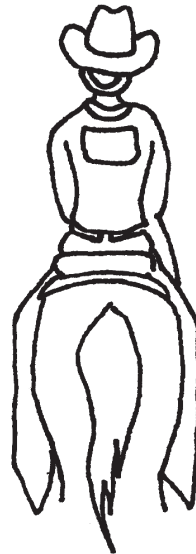

**Fig. 1**

CORRECT POSITION

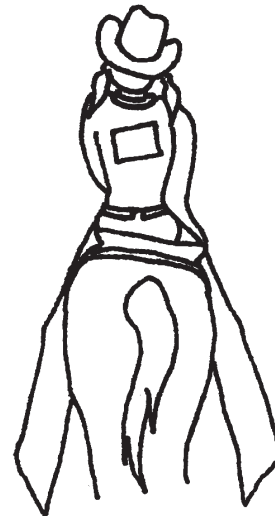

**Fig. 2**

INCORRECT POSITION

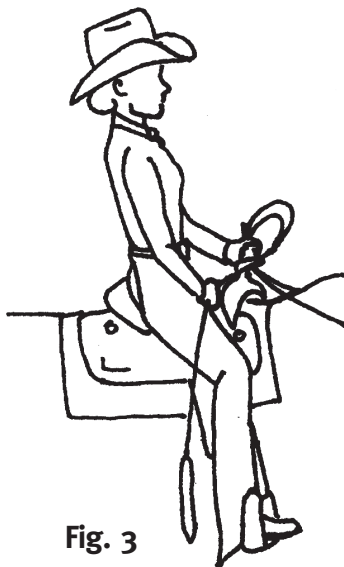

**Fig. 3**



**Fig. 4**

INCORRECT POSITIONS

*Drawings courtesy of D. Hennington*



# Western Seat/Reining Seat/ Western Horsemanship

## POSITION OF RIDER

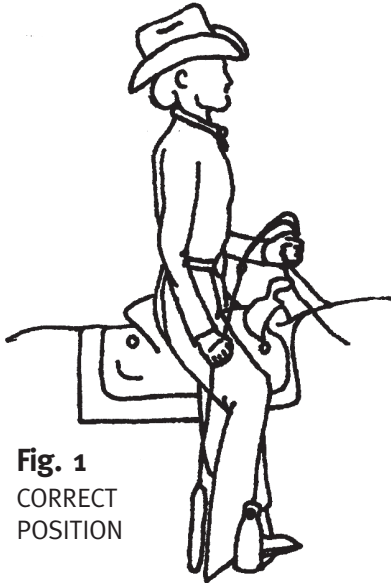

**Fig. 1**  
CORRECT  
POSITION

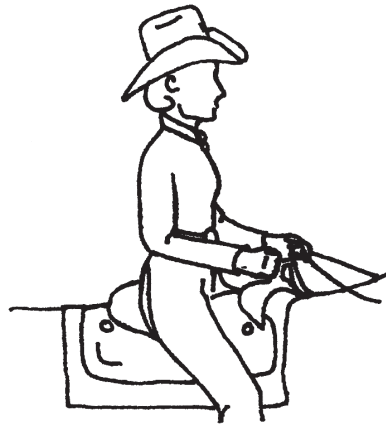

**Fig. 2**  
CORRECT  
POSITION

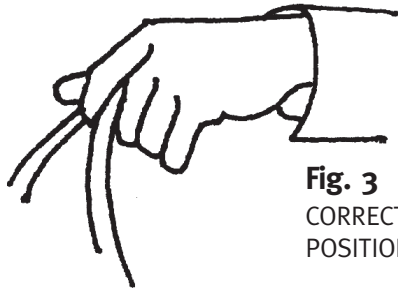

**Fig. 3**  
CORRECT  
POSITION

### CORRECT POSITIONS

#### **Fig. 1**

Rider is softly positioned with a balanced seat capable of easily responding to their horse's movements.

#### **Fig. 2**

An excellent position for your free hand and arm when riding with split reins.

#### **Fig. 3**

Proper insertion of line finger between the reins when riding with split reins.

### CORRECT POSITION FOR A SLIDING STOP

#### **Fig. 4**

Rider is balanced over Halt. Upper body maintains a near vertical position to the ground. Hands and arms are soft and flowing with the Halt. Legs have pushed slightly forward to stay balanced.

### INCORRECT POSITION FOR A SLIDING STOP

#### **Fig. 5**

Rider is leaning back bracing against the motion of the Halt. Legs are braced forward and the arms are flying free. Stopping in this position will produce a short braced stop instead of a long fluid slide.



**Fig. 4**  
CORRECT  
POSITION



**Fig. 5**  
INCORRECT  
POSITION

*Drawings courtesy of D. Hennington*

# Western Seat/Reining Seat/ Western Horsemanship

## ATTIRE OF RIDER/TACK OF HORSE

**Refer to Current  
USEF/EC Rules  
(These are  
guidelines  
and must not  
be construed  
as rules)**

1. Riders should have a long-sleeve shirt with any type of collar, a necktie, kerchief or bolo tie or broach, trousers or pants, chaps and boots. A vest, jacket, coat and/or sweater may be worn.
2. Choose clothing color that complements both you and your horse. This should present both an eye catching and a pleasant picture. Straight edge or scalloped chaps show less movement, but fringed chaps are equally acceptable. If fringed chaps are worn, the fringe should hang straight down. Remember that silver on bottoms of chaps or on stirrups accentuates any leg movement. Clothing should be well fitted; wrinkle-free and not capable of flapping when the horse is moving. The goal still remains the tall-in-the-saddle rider. To enhance this appearance, the rider may well elect to purchase a custom-made or custom-altered equitation shirt and matching pants. The outfit should be complete with matching or blending chaps, gloves, belt, boots and hat reflecting one long tall line when mounted.

The color of one's horse frequently dictates the color coordination of one's equitation outfits. A totally pale gray outfit on a gray horse may guarantee anonymity, while a jade green outfit on a bay horse will attract attention. Color, pattern, design, ornamentation, etc needs to be designed with the rider's body type in mind. Just make sure you are attracting attention to your strongest attribute as a rider. Never draw attention to your worst fault, i.e., no white or light gloves unless your hands are extremely quiet.

The western hat should fit the rider not only in circumference but the height of the crown and depth of the brim should balance and complement the individual. Hat should be kept clean, shaped and protected when not being worn. The hat should always be worn straight on the head.

A caution concerning the use of silver trim. Be sure that it is in good taste, not gaudy or overdone. It must be cleaned before each show use and be placed where it reflects the rider's strengths, such as silver stirrups for the exceptionally tight, secure-legged rider. The same is applicable to silver concho trim, don't spotlight a weak area. The amount of silver does not influence the judging.

3. Be sure the saddle is neither too large nor too small. Fenders should be twisted so that the stirrup hangs perpendicular to the horse. A caution: be sure that the equitation rider's saddle fenders are hung in a centered, not forward, rigging.

*cont'd...*

# Western Seat/Reining Seat/ Western Horsemanship

## ATTIRE OF RIDER/TACK OF HORSE

3. The bit should fit the horse's mouth and head. A 4 1/2" to 5" mouthpiece with an 8 1/2" maximum shank is standard. Be sure that the upper shank end at the side of the bit is flanged outward enough to not jab into the horse's facial bones. Even expensive bits are occasionally shaped uncomfortably for your horse. There shall be no discrimination against any standard western bit. The headstall may be of any western design. Curb chains and leather chin straps must be flat and at least 1/2" in width, and lie flat against the jaws of the horse. No wire, rawhide, metal or other substance can be used in conjunction with or as part of the leather chin strap or curb chains. A light lip strap is permissible. Horses shown in the Arabian and Half-Arabian division may not use hackamores or snaffle bits in the Equitation division and must show with one hand. Refer to the Western bit description in the Arabian chapter of the rule book.
4. In all Reining Seat classes, a current NRHA Pattern must be used. In Reining Seat classes the use of shin, bell boots and/or protective bandages on the front legs and standard sliding or rundown boots on the rear fetlocks are permitted. Exhibitor number(s) may be on the left side of the saddle pad, both sides of the saddle pad, or on the rider's back.
5. Horse should be well groomed, and tack and clothing (even bottoms of boots) should be clean and neat. Spurs may be used.
6. In Western Horsemanship classes, the rail or pattern may be conducted first. The order to reverse may be executed by turning toward or away from the rail. It is customary, the exhibitors reverse demonstrating a haunch turn.
7. Riding Side Saddle is not permitted in classes restricted to juniors.

Exhibitors are reminded to always refer to current *USEF/EC Rule Books* for specific rules regarding attire and tack. Exhibitors are reminded to refer to the current *AHA Handbook* for procedures.

# Reining Seat

## EQUITATION

Please be certain  
that these  
patterns  
correspond with  
the patterns  
printed in the  
current year  
*NRHA Division.*

### Reining

The ideal Reining horse is guided through every movement of every maneuver. The best Reining horses should exude a willing disposition with no indication of resistance. The overall impression of a superior horse and rider team in the sport of Reining is one of complete harmony in communication and effort, showing a forward expression, and exciting bursts of power and speed tempered by quiet moments of peacefulness and above all, an obvious demonstration of athleticism in honor of the ranching origins of the sport. A movement on the horse's own is considered a rider's lack of control. A deviation from the pattern will be considered a lack of control or temporary loss of control and therefore must be marked down according to established scoring system. After deducting all faults, set in the included scoring system, and considering the horse and rider's overall performance, credit will be given for smoothness, finesse, attitude, quickness and authority of performing various maneuvers, while using controlled speed. This raises the difficulty level and makes the sport more exciting and pleasing to watch to an audience. The scoring system shall be specified in the Judges Guide.

### Patterns

1. Current NRHA Division patterns must be used.
2. The following patterns are to be worked as stated, not as drawn. The drawn pattern is just to give the idea of what the pattern will look like in the arena.
3. Markers will be placed on the wall or fence of the arena as follows:
  - (i) at the center of the arena
  - (ii) at least 50 feet from each end of the wall
4. Where designated in the pattern for stops to be beyond a marker, the horse should begin his stop after he passes the specified marker.
5. Each pattern is drawn so that the bottom of the page represents the end of the arena entered by contestants and must be run as such. In the event that an arena has only one gate and it be in the exact middle of the side, that side shall represent the right side of the page the pattern is drawn on.
6. All horses will be judged immediately upon entering the arena and judging will cease after the last maneuver. Any fault incurred prior to the commencement of a pattern will be scored according to the rules for judging.
7. All judges' decisions are final.

# Reining Seat

## EQUITATION

### Scoring

The scoring of reining horses is on a positive numeric scale with 70 denoting a correct performance. NRHA patterns are comprised of several distinct maneuver groups which judges are asked to evaluate on an individual basis depending on execution as dictated by the pattern description and the rules for judging. The individual maneuvers are scored in 1/2 point increments from a low of -1 1/2 (extremely poor quality) to a high of +1 1/2 (excellent quality) with a score of 0 denoting a maneuver that is correct with no degree of difficulty. The total of the scores applied to the maneuver groups is combined with the starting score of 70 and from this gross maneuver score, any penalties are deducted to calculate the horse's final score, which is announced after each horse works.

The equitation of the exhibitor will be scored with a starting score of 70 and each maneuver being scored from a high of + 1 1/2 to a low of -1 1/2.

The total score is the combined reining score and equitation score.

### Quick Reference for Scores

- Correct performance = 70
- Individual maneuvers range from:
  - Extremely poor quality = -1 1/2
  - Excellent quality = + 1 1/2

**To rein a horse is not only to guide him, but also to control his every movement.**

EVENT: \_\_\_\_\_

**AHA REINING SEAT EQUITATION SCORE SHEET**

CLASS # : \_\_\_\_\_ JUDGE: \_\_\_\_\_ # of ENTRIES: \_\_\_\_\_  
 PATTERN: \_\_\_\_\_ DATE: \_\_\_\_\_

Class Specifications: The Reining Seat Equitation Class is an equitation class requiring riders to perform a reining pattern. Riders will be judged on seat, hands, performance of horse, appointments of horse and rider and suitability of horse to rider. Results as shown by the performance of the horse are NOT to be considered more important than the method used in obtaining them.

A rider who is off pattern will be disqualified and will not receive any award except in a work-off in the case of a tie where the rider will be placed last of those chosen for the work off. Bits must be dropped and inspected by the judge or designated official, and all riders must dismount for this inspection.

**All competitors enter the arena with a Reining Score of 70 and an Equitation Score of 70 for a Total Score of 140**  
**Use NRHA/USEF Scoring System for Penalties and Maneuvers**  
**Equitation is scored from 70, +1-1/2 to -1-1/2 for each maneuver**

		1	2	3	4	5	6	7	8	SUB	Rng Score	Eq. Score	TOTAL
ENTRY#	PENALTY												
	MANVR.												
	EQUIT.												
		1	2	3	4	5	6	7	8	SUB	Rng Score	Eq. Score	TOTAL
ENTRY#	PENALTY												
	MANVR.												
	EQUIT.												
		1	2	3	4	5	6	7	8	SUB	Rng Score	Eq. Score	TOTAL
ENTRY#	PENALTY												
	MANVR.												
	EQUIT.												
		1	2	3	4	5	6	7	8	SUB	Rng Score	Eq. Score	TOTAL
ENTRY#	PENALTY												
	MANVR.												
	EQUIT.												
		1	2	3	4	5	6	7	8	SUB	Rng Score	Eq. Score	TOTAL
ENTRY#	PENALTY												
	MANVR.												
	EQUIT.												
		1	2	3	4	5	6	7	8	SUB	Rng Score	Eq. Score	TOTAL
ENTRY#	PENALTY												
	MANVR.												
	EQUIT.												

JUDGES SIGNATURE: \_\_\_\_\_

# Reining Seat PATTERNS

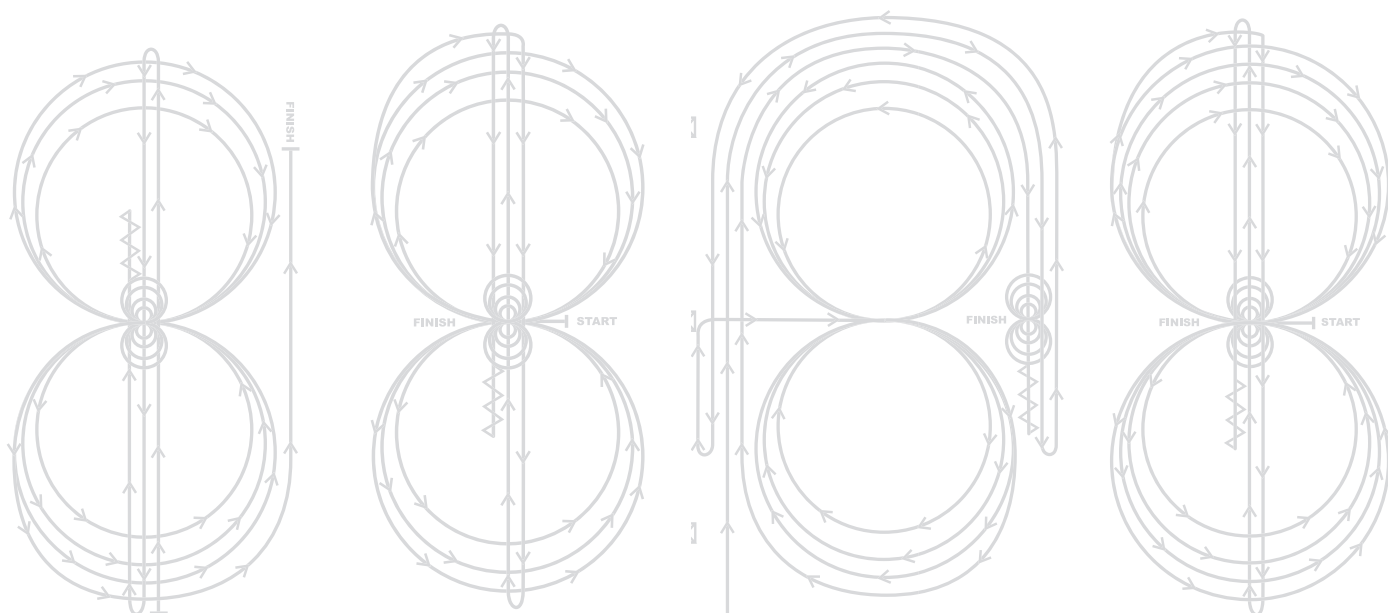

## Patterns & Scorecards

Judges & Show Managers: Please use only current patterns from website

[nrha.com/media/pdf/handbook/2024/patterns.pdf](http://nrha.com/media/pdf/handbook/2024/patterns.pdf)

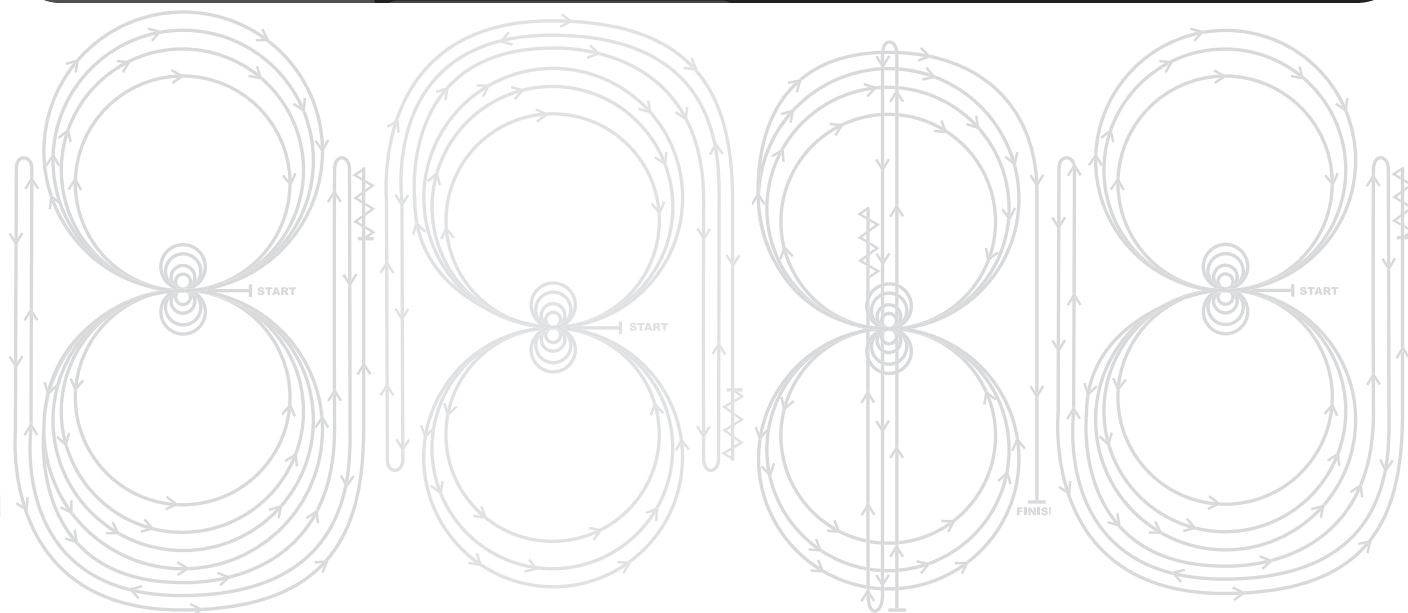

# Western Horsemanship

## CLASS ROUTINE / PATTERNS & TESTS

Refer to the Western Seat/Reining Seat Equitation chapter of this book for the rider position and attire

The Western Horsemanship Equitation class was introduced in the Arabian division in 1989 in order to fill a need for stock seat equitation riders who did not own or have access to a horse capable of fulfilling the requirements of a reining horse pattern. The Western Horsemanship pattern consists of maneuvers that a properly trained western horse could accomplish. A pattern is required in this class, but unlike stock seat/reining seat classes, the Western Horsemanship class is judged 50 percent on the rail work and 50 percent on the pattern work. Patterns are typically performed out of the lineup at local AHA-recognized shows. Regional and National classes must be excused from the arena to work patterns individually. No flying lead changes or sliding stops are permitted in this class.

### Class Routine

Class typically enters at the jog going to the right and continuing counterclockwise. Riders may be asked to walk and then lope or go directly into the lope from the jog. Riders may be asked to reverse and walk or they may be asked to reverse at the jog. Riders then continue the second way of the ring and demonstrate the walk, jog and lope. Riders typically come to the lineup at the jog.

Tests will include at least four of the following:

1. Back in a straight or curved line.
2. Walk, jog, and/or lope in a straight line, curved line, serpentine, circle or figure eight, or combination of these gaits and maneuvers.
3. Stop.
4. Demonstrate simple changes of lead. (In a simple change of lead the horse is brought back to a walk or jog and restarted into the lope on the opposite lead.)
5. Execute turns on the forehand of 90 degrees or greater turning either direction or both, with the hindquarters moving around a relatively stationary forehand.
6. Execute turns on the haunches of 90 degrees or greater (maximum 540 degrees each direction) turning either direction or both. Deep flexion of the hocks and speed of the turn is not to be valued over the accuracy and smoothness of the pivot.)
7. Sidepass.
8. Ride without stirrups.
9. Counter lope.
10. Extended jog and/or lope.

13 & under/14 and under tests 1-7 and 10; 14-18, 18 & Under and 19 & Over Tests 1-10.

For a complete list of the tests to be used, please refer to the current USEF/EC Rule Books. Judges must include at least four of these tests in their patterns, and patterns must be posted at least one hour prior to the class.

In Western Horsemanship classes, the rail or pattern may be conducted first. It is customary during the rail portion, that the exhibitors reverse demonstrating a haunch turn. A turn on the forehand to the right is accomplished by moving haunches to the left. A forehand turn to the left is accomplished by moving haunches to the right.

Riders are being evaluated from the moment they enter the arena until they exit. Completion of the pattern is not the end of the adjudication period.

Cones or markers may be used to mark the pattern in arena. Exhibitors are reminded to always refer to current USEF/EC Rule Books for specific rules regarding Western Horsemanship. Exhibitors are reminded to refer to the current AHA Handbook for procedures.



# Western Horsemanship

## SUGGESTED SCORE SHEET



### Western Horsemanship Score Sheet

Class: \_\_\_\_\_ Show: \_\_\_\_\_

Date: \_\_\_\_\_ Judge: \_\_\_\_\_

Working Order	Entry Number	50% Rail/50% Pattern				Off Pattern is not Elimination			Pattern Score	Rail Score	Combined Score	Comments	Placing
		1	2	3	4	5	6	7					
1													
2													
3													
4													
5													
6													
7													
8													
9													
10													
11													
12													
13													
14													
15													
16													
17													
18													
19													
20													

**Maneuver Evaluation - Showmanship 70%**

- + = above average
- ✓ = average
- = below average
- An additional + or - may be given

**Faults**

- m = Minor Fault
- (M) = Major Fault
- S = Severe Fault
- E = Elimination

# Western Horsemanship

## SCORING

**+ = above average**

**✓ = average**

**– = below average**

**An additional + or – may be given**

### **90-100 EXCELLENT**

Excellent rider, including body position and use of aids. Completes pattern accurately, quickly, smoothly and precisely while demonstrating a high level of professionalism.

### **80-89 VERY GOOD**

Very good performance in execution of the pattern as well as correct horsemanship and use of aids. Excellent horseman that commits a minor fault.

### **70-79 GOOD**

Good pattern execution and average horsemanship lacking adequate style and professional presentation to merit elevating to the next scoring range. A very good rider that commits a minor fault or an excellent horseman that commits a major fault.

### **60-69 FAIR**

Fair pattern that lacks quickness or precision or rider has obvious position and/or appearance faults that prevents effective horsemanship; or a good horseman that commits a minor fault in the performance. A very good rider with a major fault. An excellent rider that commits a severe fault.

### **50-59 BELOW AVERAGE**

One major fault or multiple minor faults in the performance. A rider that demonstrates a lack of riding ability and knowledge of correct body position.

### **40-49 POOR**

A rider that commits a severe fault, 2 or more major faults or multiple minor faults in the performance or the exhibitor that demonstrates a lack of riding ability and knowledge of correct body position.

### **10-39 EXTREMELY POOR**

A rider that commits more than one severe fault or multiple major faults in performance or exhibits poor riding skills but completes the class and avoids disqualification.

# Western Horsemanship

## FAULTS

### Minor Faults (m)

Break of gait at walk or jog up to 2 strides  
 Over/under turn up to 1/8 of turn  
 Incorrect position  
 Dirty, ungroomed outfit, horse or equipment  
 Unfitted equipment

### Major Faults (M)

Break of gait at a lope, out of lead or missing lead for 1-2 strides  
 Not stopping within 10 feet of designated area  
 Incorrect gait or break of gait at walk or jog for more than 2 strides  
 Over turn of more than 1/8 turn, but not more than 1/4  
 Exhibitor obviously looking down to check leads  
 Failure of bottom of boot to be in contact with the pad of the stirrup  
 Head carried too high  
 Head carried too low (tip of ear below the withers)  
 Over flexing or straining neck in head carriage so the nose is carried behind the vertical  
 Excessive nosing out  
 Freeze up  
 Touching horse or saddle to prevent fall  
 Undesirable or excessive motion in legs — we have an active leg in extended jog definition

### Severe Faults (S)

*avoids disqualification, but should be placed below exhibitors who do not incur a sever fault*

Loss of stirrup or rein  
 Missing a lead for more than 2 strides  
 Over turning more than 1/4 of prescribed turn  
 Grabbing the saddle horn or any other part of the saddle  
 Inclusion or exclusion of maneuver not specified  
 Cueing with the end of the romal  
 Failure to follow pattern correctly including failure to ever execute correct lead or gait where called for  
 Kicking at other horses, exhibitors or judge  
 Severe disobedience or resistance by horse including, but not limited to: rearing, bucking, pawing  
 Knocking over the marker, going off pattern or working on wrong side of marker

### Elimination (E) *may not be placed*

Inhumane treatment and undue stress  
 Excessive schooling or training  
 Fall of horse or rider  
 Illegal use of hands on reins  
 Use of prohibited equipment  
 Spurring/kicking in front of cinch  
 Equipment failure that delays completion of the pattern or rail

# WESTERN HORSEMANSHIP

---

## Level 1

The following patterns are appropriate  
for ALL ages

# Western Horsemanship

## LEVEL 1 • PATTERN A

*The drawn description of this pattern is only intended for the general depiction of the pattern. Exhibitors should utilize the arena to best exhibit their horses.*

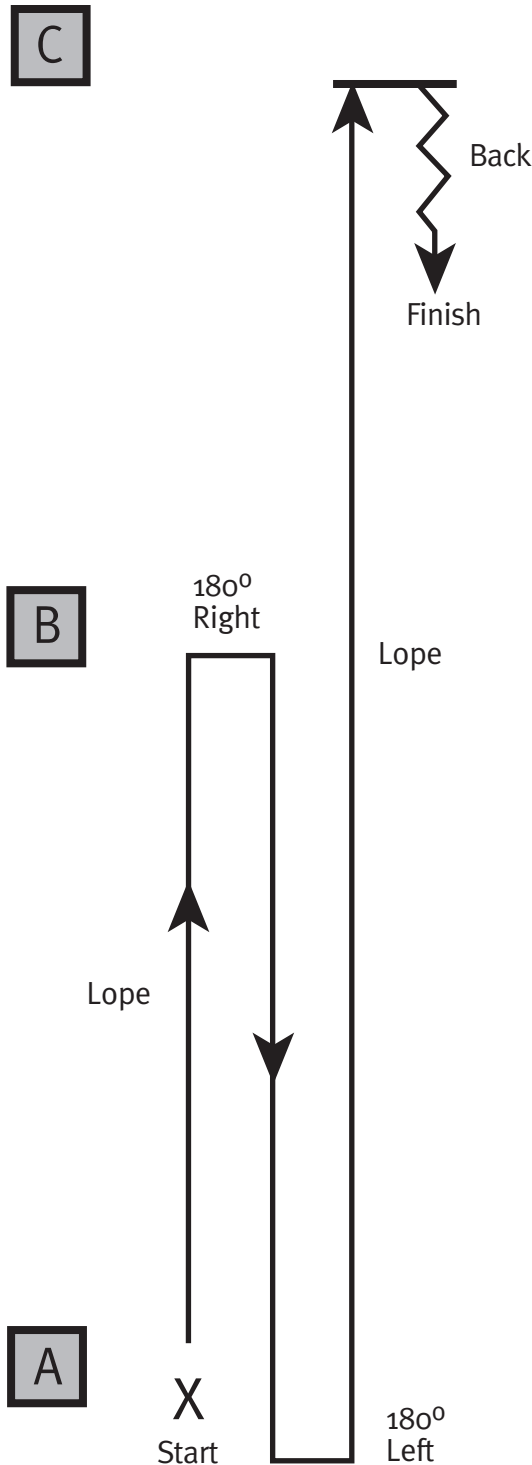

Be ready at Marker A.

Starting at Marker A, lope left lead to Marker B. Stop.

At Marker B, turn 180-degrees on hindquarters right.

Lope right lead to Marker A.

Stop at Marker A, and turn 180-degrees on hindquarters left.

Lope left lead to Marker C.

Stop at Marker C and back approximately ten feet.

After completing pattern, jog to far end of arena and form a new line or exit arena at the jog.

	Stop / Halt
	Lope
	Jog
	Walk
	Back
	Marker
	Lineup

*This pattern is appropriate to use for all age groups*

*If used at a Regional or National Show, pattern may not be run from the lineup.*

# Western Horsemanship

## LEVEL 1 • PATTERN B

The drawn description of this pattern is only intended for the general depiction of the pattern. Exhibitors should utilize the arena to best exhibit their horses.

Be ready at marker A.

Lope right lead to marker B.  
Stop.

Execute a 3/4 turn on the hindquarters to the left.

Lope left lead to marker C.

Stop and back approximately ten feet.

Return to lineup at the jog or exit arena at the jog.

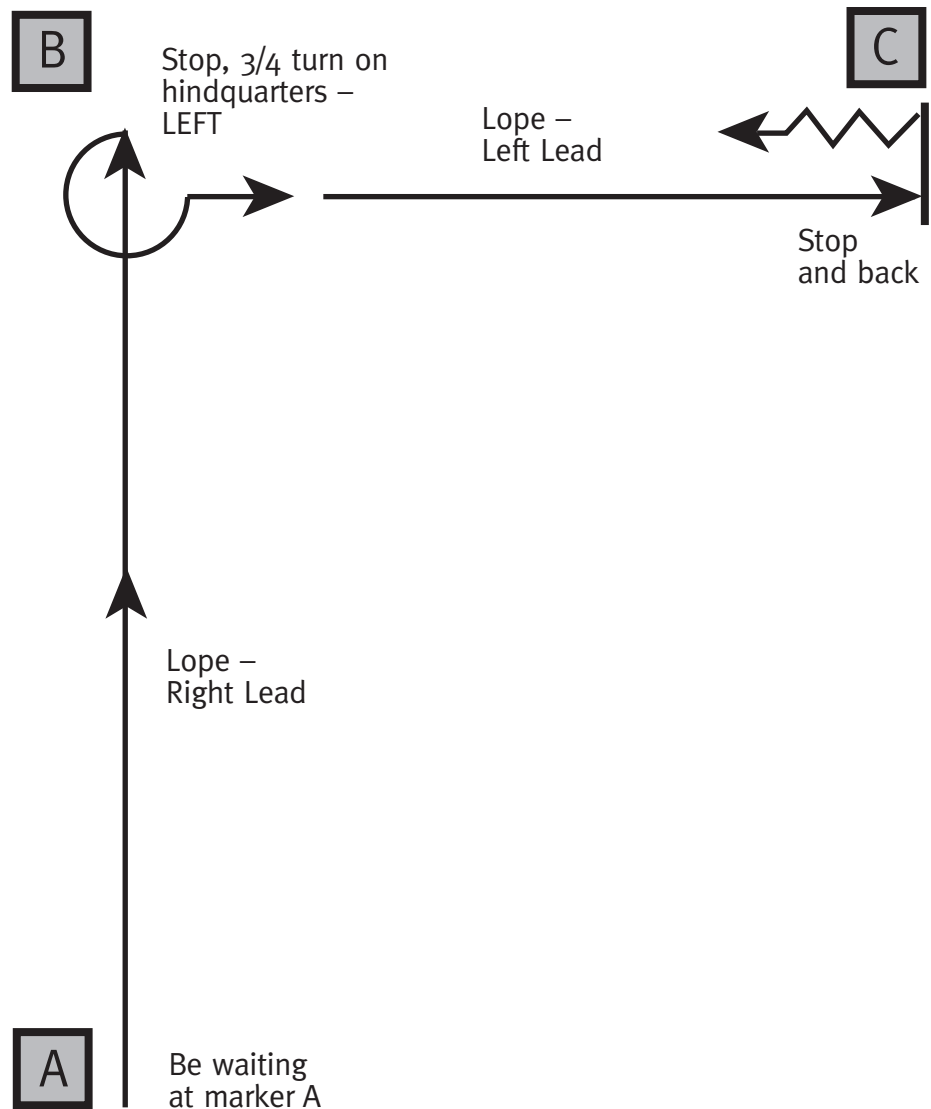
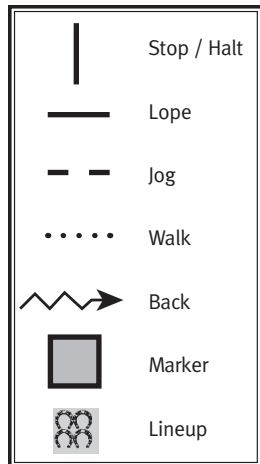

This pattern is appropriate to use for all age groups

If used at a Regional or National Show, pattern may not be run from the lineup.

# Western Horsemanship

## LEVEL 1 • PATTERN C

*The drawn description of this pattern is only intended for the general depiction of the pattern. Exhibitors should utilize the arena to best exhibit their horses.*

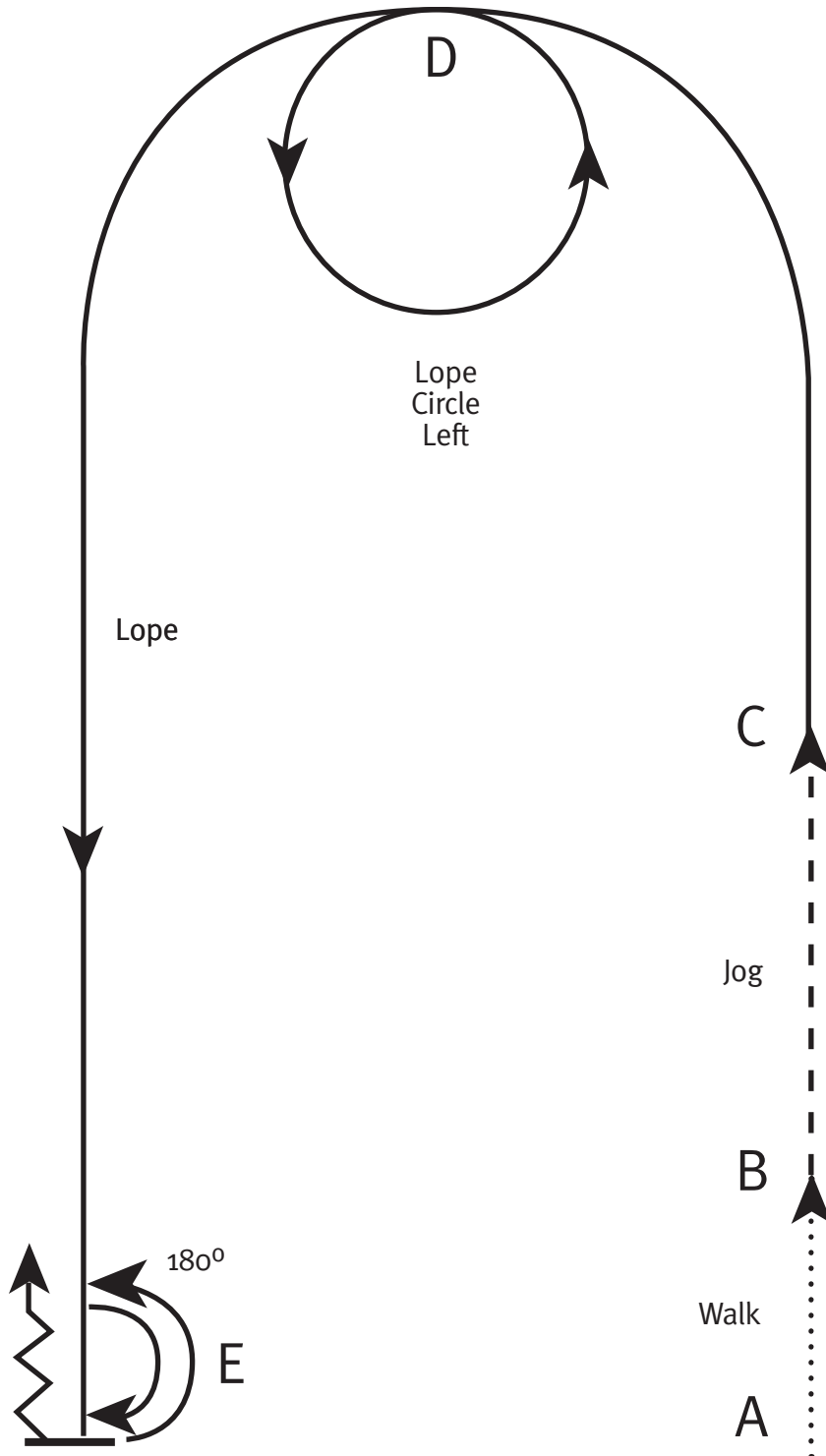

- Be ready at marker A.
- Walk from marker A to marker B.
- Jog to marker C.
- Lope on the left lead to marker D.
- Continue to lope a circle on the left lead around marker D and continue to marker E. Stop.
- Execute a 180-degree on hindquarters to the left.
- Execute a 180-degree turn on hindquarters to the right.
- Back four steps.
- Return to the lineup at the jog or exit arena at the jog.

	Stop / Halt
	Lope
	Jog
	Walk
	Back
	Marker
	Lineup

*This pattern is appropriate to use for all age groups.*

*If used at a Regional or National Show, pattern may not be run from the lineup.*

# Western Horsemanship

## LEVEL 1 • PATTERN D

*The drawn description of this pattern is only intended for the general depiction of the pattern. Exhibitors should utilize the arena to best exhibit their horses.*

Be ready at marker A.

Lope a two loop serpentine beginning on the right lead showing one simple change (walk or jog) of lead.

Stop at marker C turn 180-degrees on haunches to the right.

Lope on right lead to marker D.

Stop at marker D and back four steps.

Return to the lineup at the jog or exit arena at the jog.

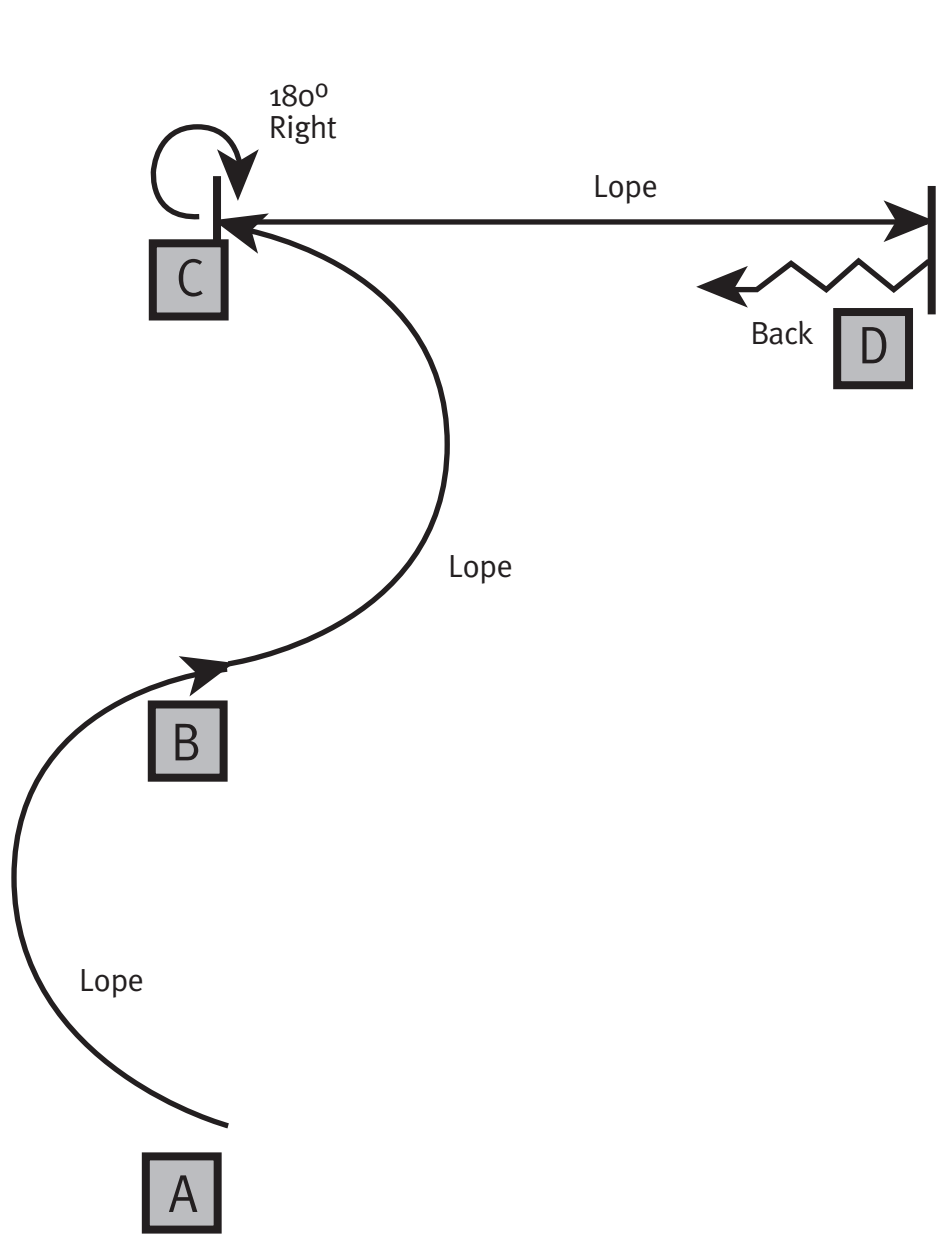
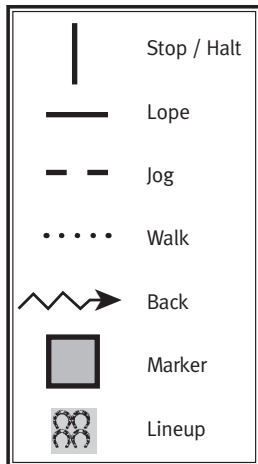

*This pattern is appropriate to use for all age groups*

*If used at a Regional or National Show, pattern may not be run from the lineup.*







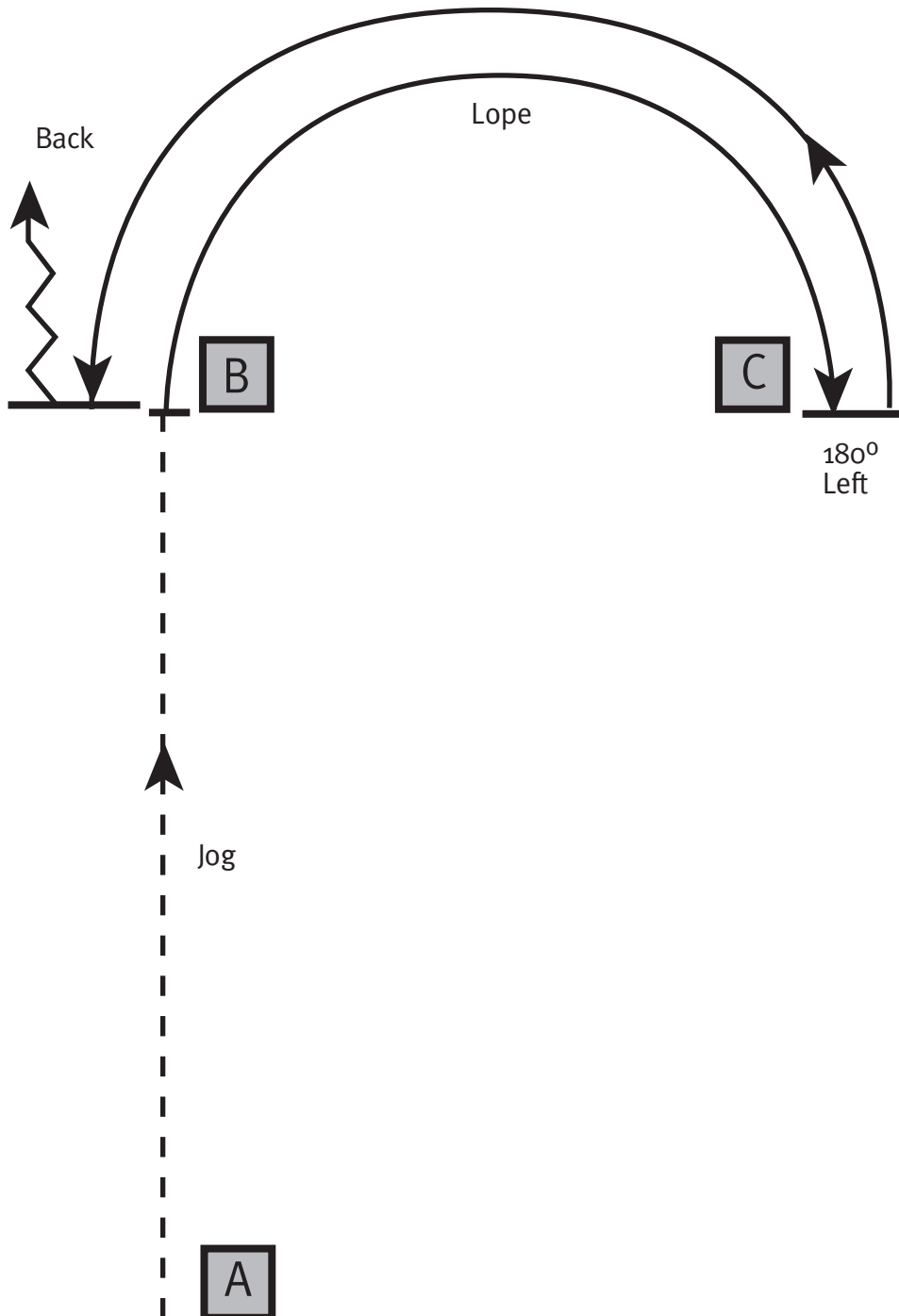

# Western Horsemanship

## LEVEL 1 • PATTERN E

*The drawn description of this pattern is only intended for the general depiction of the pattern. Exhibitors should utilize the arena to best exhibit their horses.*



- Be ready at marker A.
- Jog to marker B. Stop.
- Lope a semi-circle on the right lead to marker C.
- Stop.
- Turn 180-degrees on the haunches to the left.
- Lope a semi-circle on the left lead to marker B.
- Stop.
- Back approximately five steps.
- Return to the lineup at the jog or exit the arena at the jog.

	Stop / Halt
	Lope
	Jog
	Walk
	Back
	Marker
	Lineup

*This pattern is appropriate to use for all age groups*

*If used at a Regional or National Show, pattern may not be run from the lineup.*

# Western Horsemanship

## LEVEL 1 • PATTERN F

The drawn description of this pattern is only intended for the general depiction of the pattern. Exhibitors should utilize the arena to best exhibit their horses.

Be ready at marker A.

Jog from marker A to marker B.

Lope a circle on the right lead.

Continue out of the circle at a lope and simple change (walk or jog) to the left lead before marker C.

Lope a left circle on left lead at marker C.

Continue on the left lead to marker D.

Stop and back ten feet.

Return to the lineup at the jog or exit the arena at the jog.

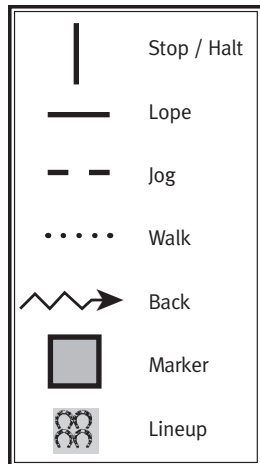

This pattern is appropriate to use for all age groups

If used at a Regional or National Show, pattern may not be run from the lineup.

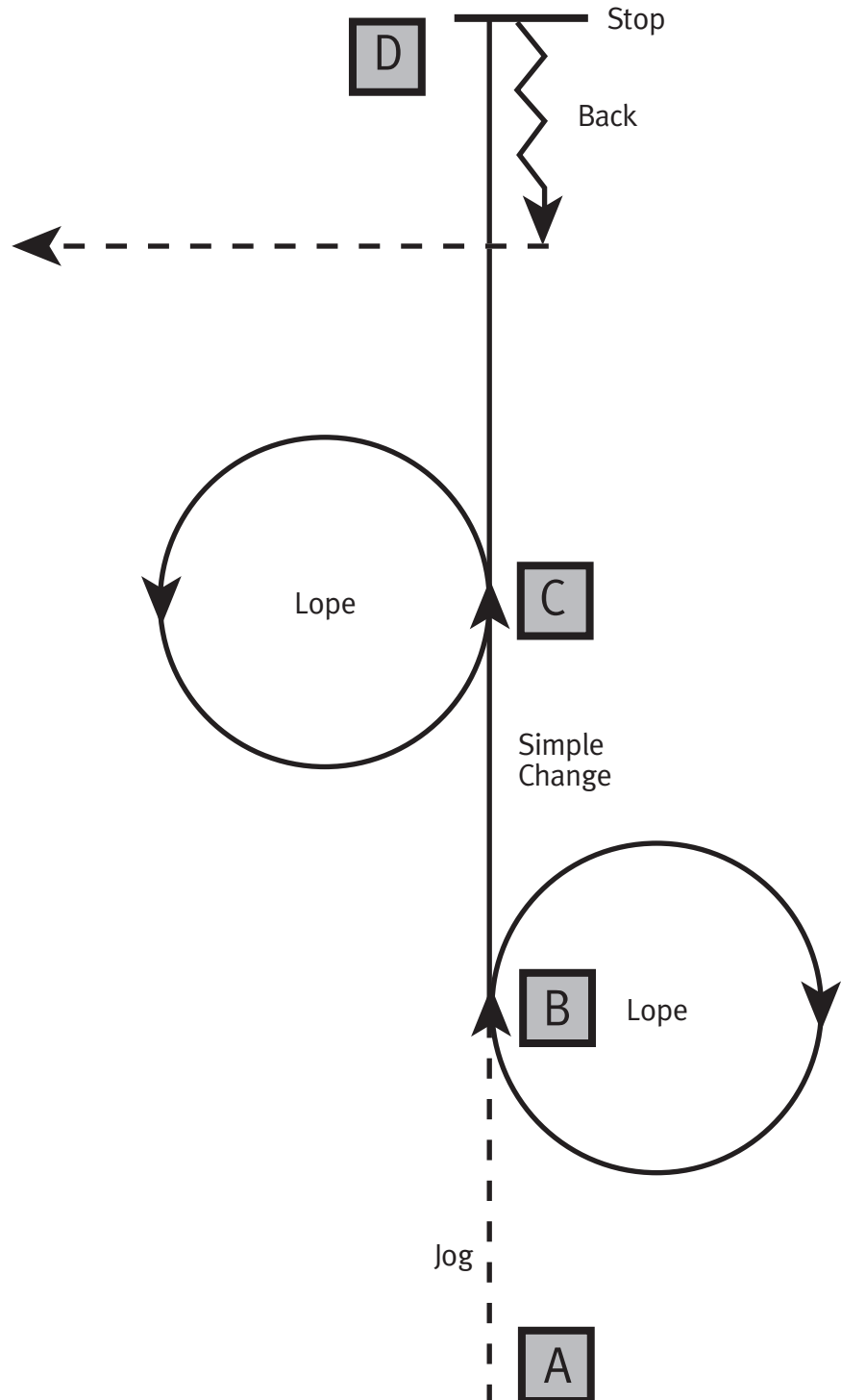

# Western Horsemanship

## LEVEL 1 • PATTERN G

*The drawn description of this pattern is only intended for the general depiction of the pattern. Exhibitors should utilize the arena to best exhibit their horses.*

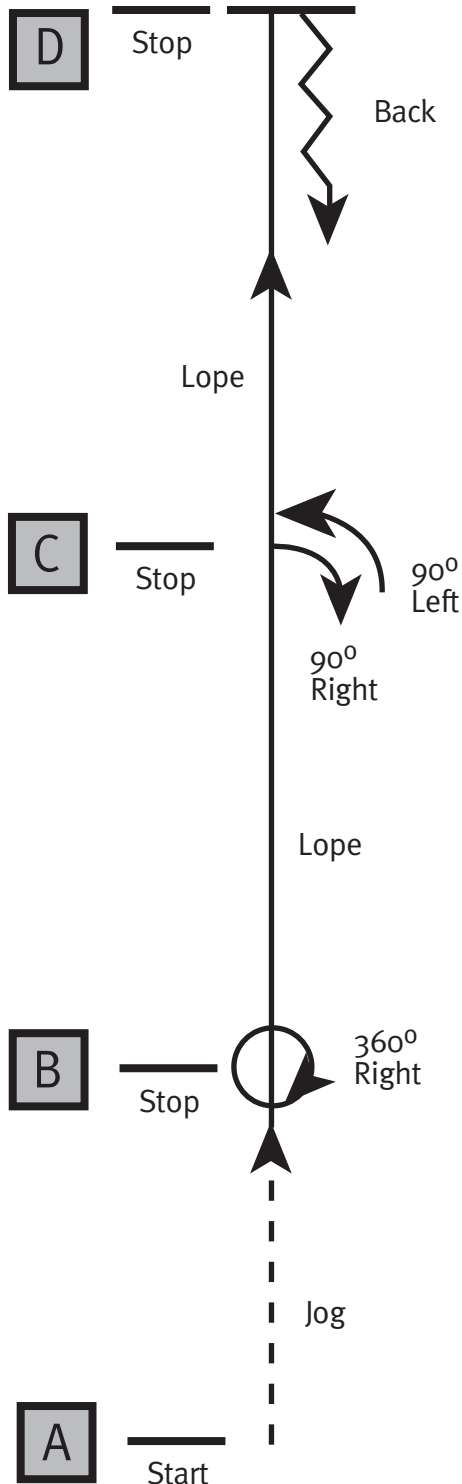

Be ready at marker A.

Jog to marker B. Stop

Make a 360-degree turn to the right on the hindquarters.

Lope right lead to marker C. Stop.

Make a 90-degree turn on hindquarters to the right.

Make a 90-degree turn on hindquarters to the left.

Lope left lead to marker D.

Stop at marker D and back five steps.

Return to lineup at the jog or exit the arena at the jog.

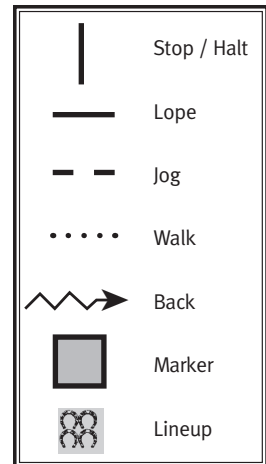

*This pattern is appropriate to use for all age groups*

*If used at a Regional or National Show, pattern may not be run from the lineup.*

# Western Horsemanship

## LEVEL 1 • PATTERN H

The drawn description of this pattern is only intended for the general depiction of the pattern. Exhibitors should utilize the arena to best exhibit their horses.

Be ready at A.

Lope on the left lead to B and stop.

Execute 270-degree turn to the right.

Lope on the right lead to C, continuing at the lope, make a small circle continuing to D and stop.

Execute a 180-degree turn to the left.

Jog to E. Stop and back ten feet.

Return to line or exit at a jog.

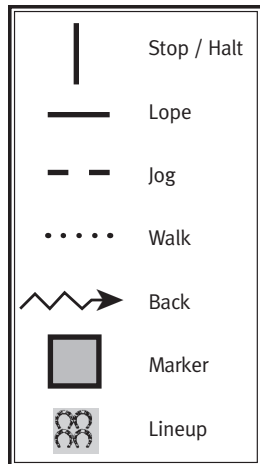

This pattern is appropriate to use for all age groups

If used at a Regional or National Show, pattern may not be run from the lineup.

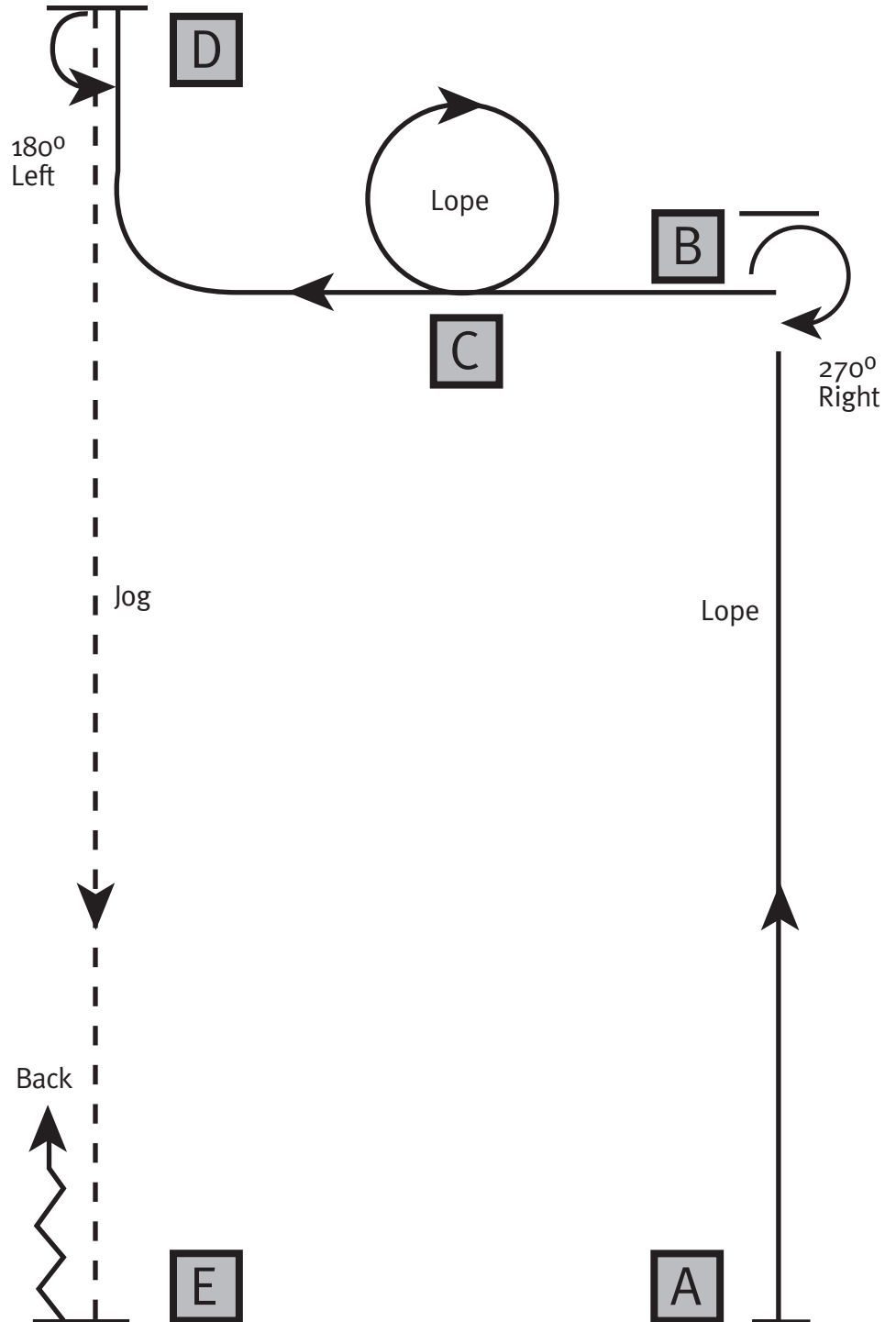

# Western Horsemanship

## LEVEL 1 • PATTERN J

*The drawn description of this pattern is only intended for the general depiction of the pattern. Exhibitors should utilize the arena to best exhibit their horses.*

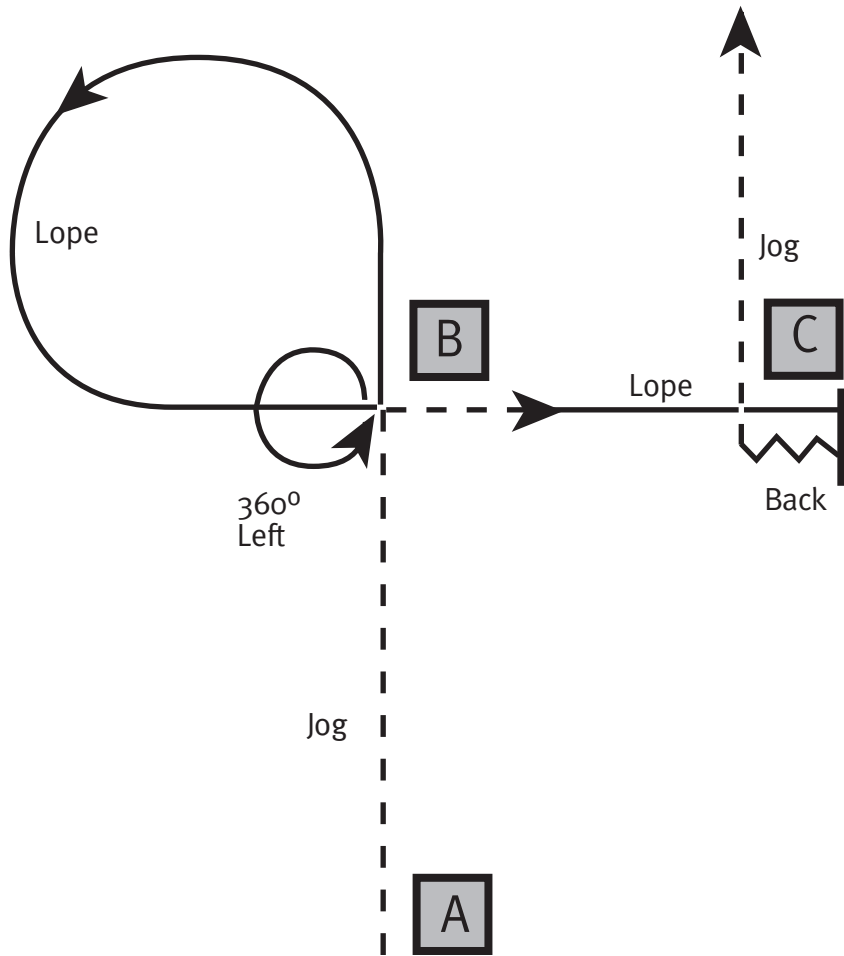

Be ready at A.

Jog to B.

Execute 360-degree turn on haunches to left.

Lope left lead back to B.

Simple lead change (walk or jog).

Lope right lead to C and stop.

Back nine steps.

Return to lineup at the jog or exit arena at the jog.

	Stop / Halt
	Lope
	Jog
	Walk
	Back
	Marker
	Lineup

*This pattern is appropriate to use for all age groups*

*If used at a Regional or National Show, pattern may not be run from the lineup.*

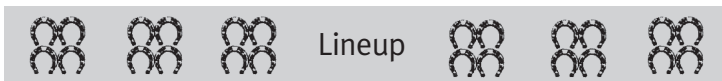

# Western Horsemanship

## LEVEL 1 • PATTERN K

The drawn description of this pattern is only intended for the general depiction of the pattern. Exhibitors should utilize the arena to best exhibit their horses.

Be ready at marker A.

Pick up the left lead and lope to marker B.

Stop and pivot 360-degrees on hindquarters right.

Pick up right lead, lope a circle to right and lope to marker C.

Stop and pivot 360-degrees on hindquarters left.

Pick up left lead, lope circle to the left and lope to marker D.

Stop at marker D and back approximately ten feet.

Return to the lineup at the jog or exit arena at the jog.

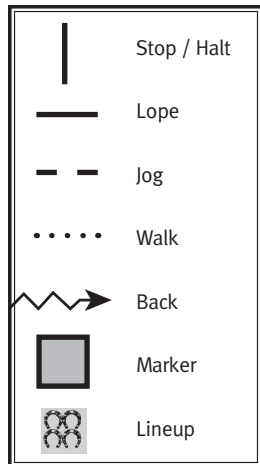

This pattern is appropriate to use for all age groups

If used at a Regional or National Show, pattern may not be run from the lineup.

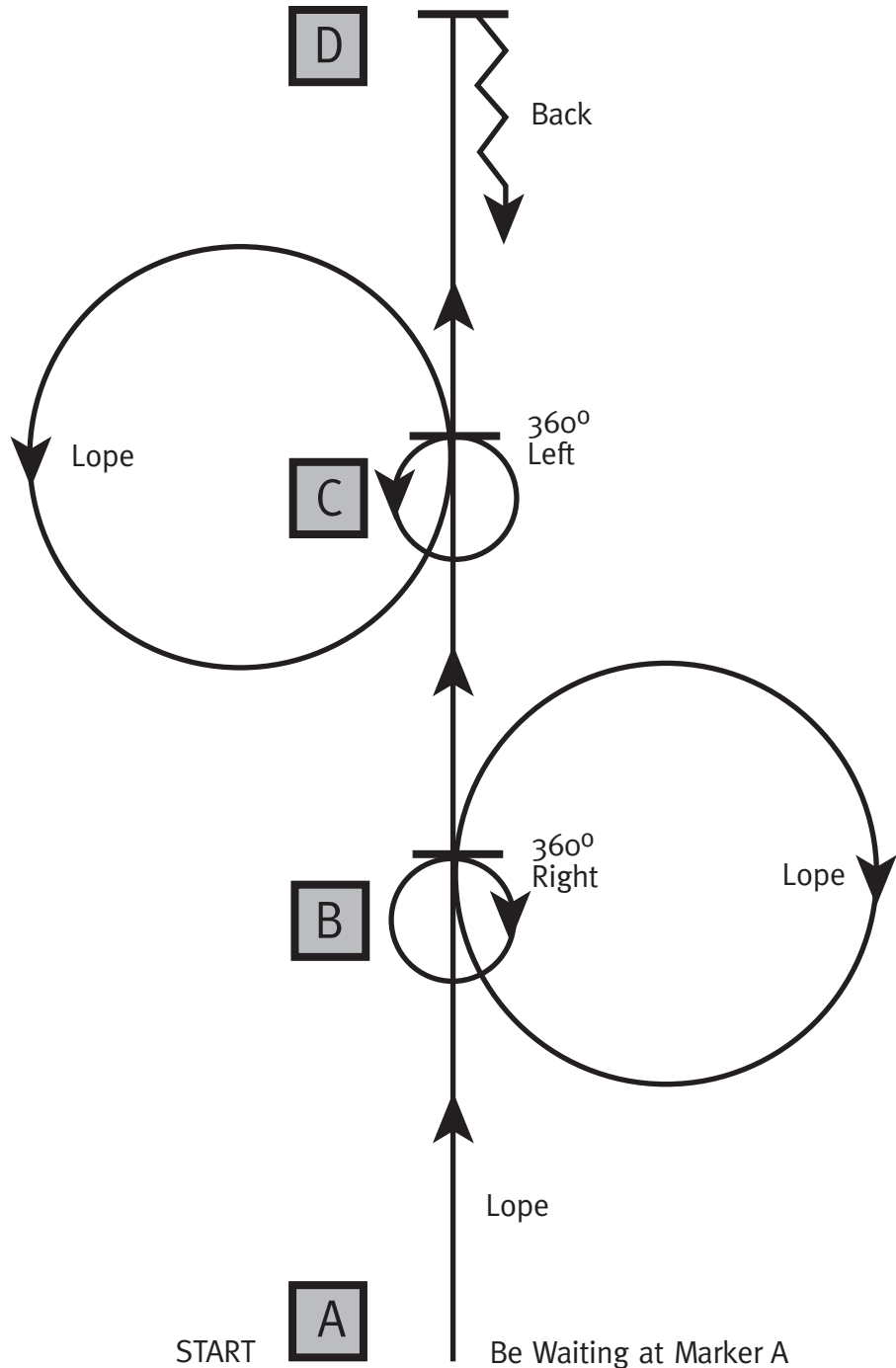

# Western Horsemanship

## LEVEL 1 • PATTERN L

*The drawn description of this pattern is only intended for the general depiction of the pattern. Exhibitors should utilize the arena to best exhibit their horses.*

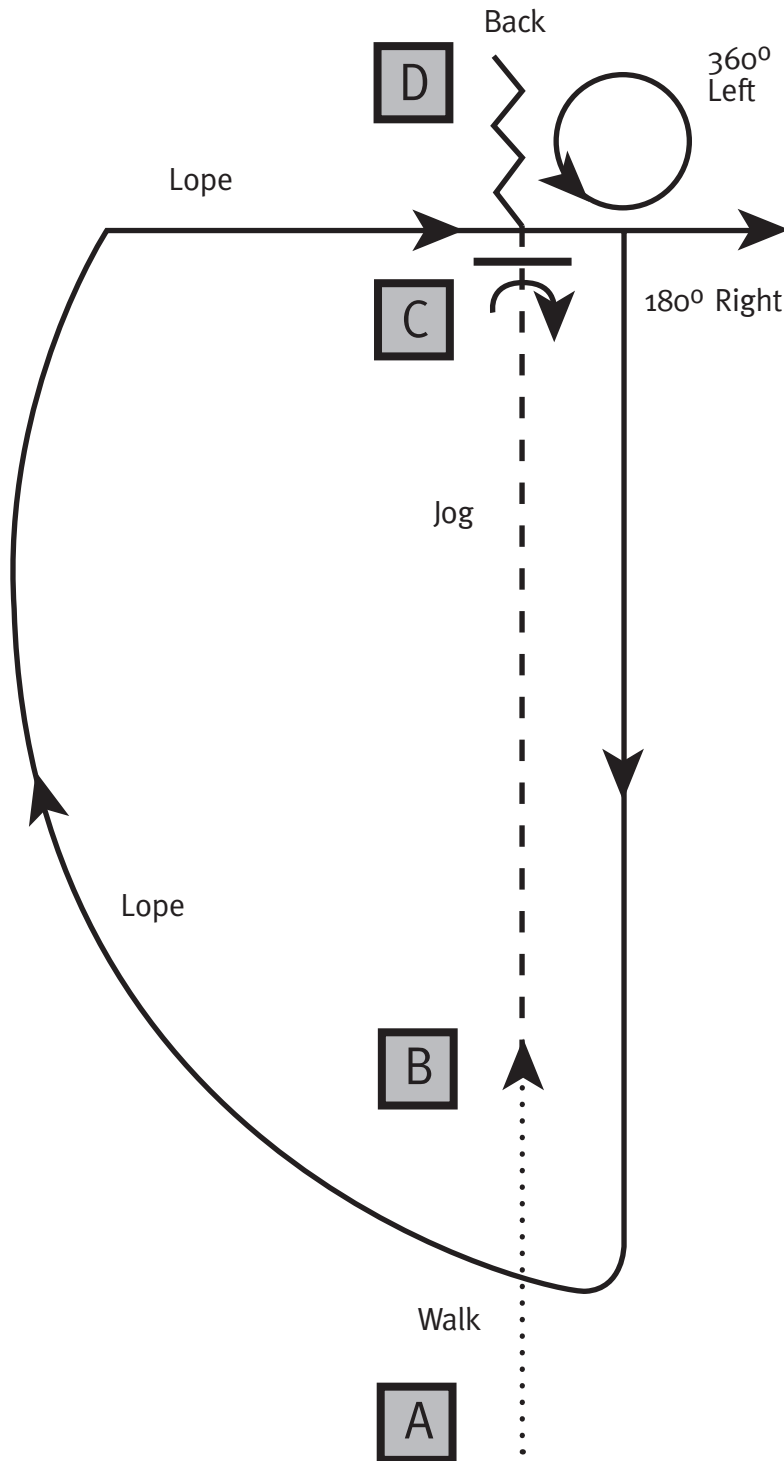

Be ready at marker A.

Walk to marker B.

Jog to marker C and stop.

Make a 180-degree turn to the right on the hindquarters.

Back to marker D.

Make a 360-degree turn to the left on the hindquarters.

Lope right lead around marker B and proceed through marker C and marker D to rail. Stop.

Return to the lineup at the jog or exit arena at the jog.

	Stop / Halt
	Lope
	Jog
	Walk
	Back
	Marker
	Lineup

*This pattern is appropriate to use for all age groups*

*If used at a Regional or National Show, pattern may not be run from the lineup.*

# Western Horsemanship

## LEVEL 1 • PATTERN M

The drawn description of this pattern is only intended for the general depiction of the pattern. Exhibitors should utilize the arena to best exhibit their horses.

Be ready at marker A.

Walk to marker B.

Jog to marker C. Stop.

Make a 360-degree turn on the haunches to the right. Lope on the left lead and circle back to marker C.

At marker C demonstrate simple change of lead (walk or jog) and lope right lead to marker D.

Stop at marker D and back ten feet.

Return to lineup at the jog or exit the arena at the jog.

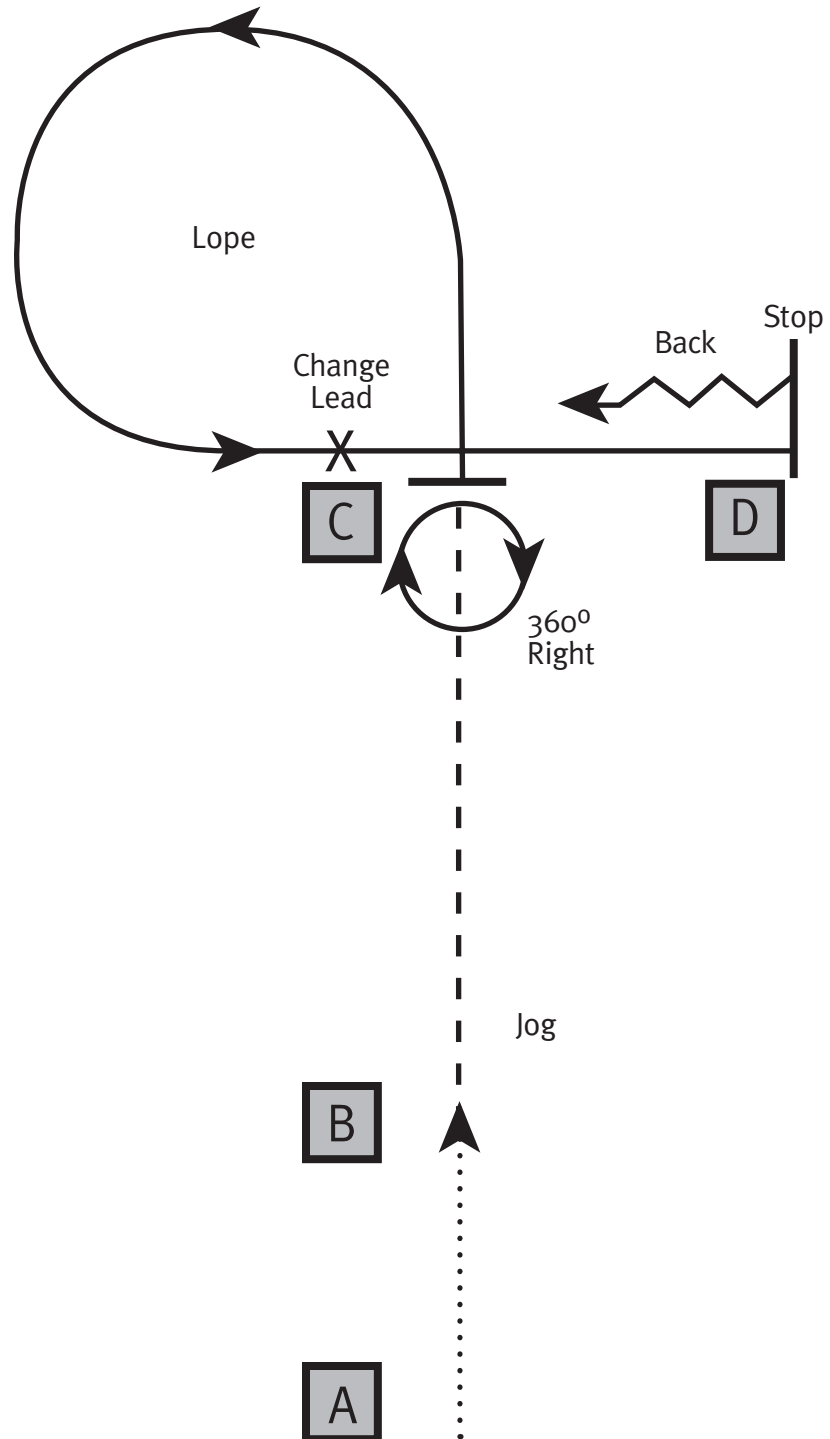
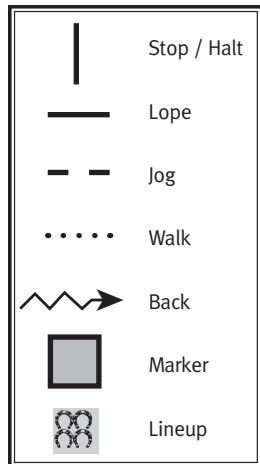

This pattern is appropriate to use for all age groups

If used at a Regional or National Show, pattern may not be run from the lineup.



# Western Horsemanship

## LEVEL 1 • PATTERN N

*The drawn description of this pattern is only intended for the general depiction of the pattern. Exhibitors should utilize the arena to best exhibit their horses.*

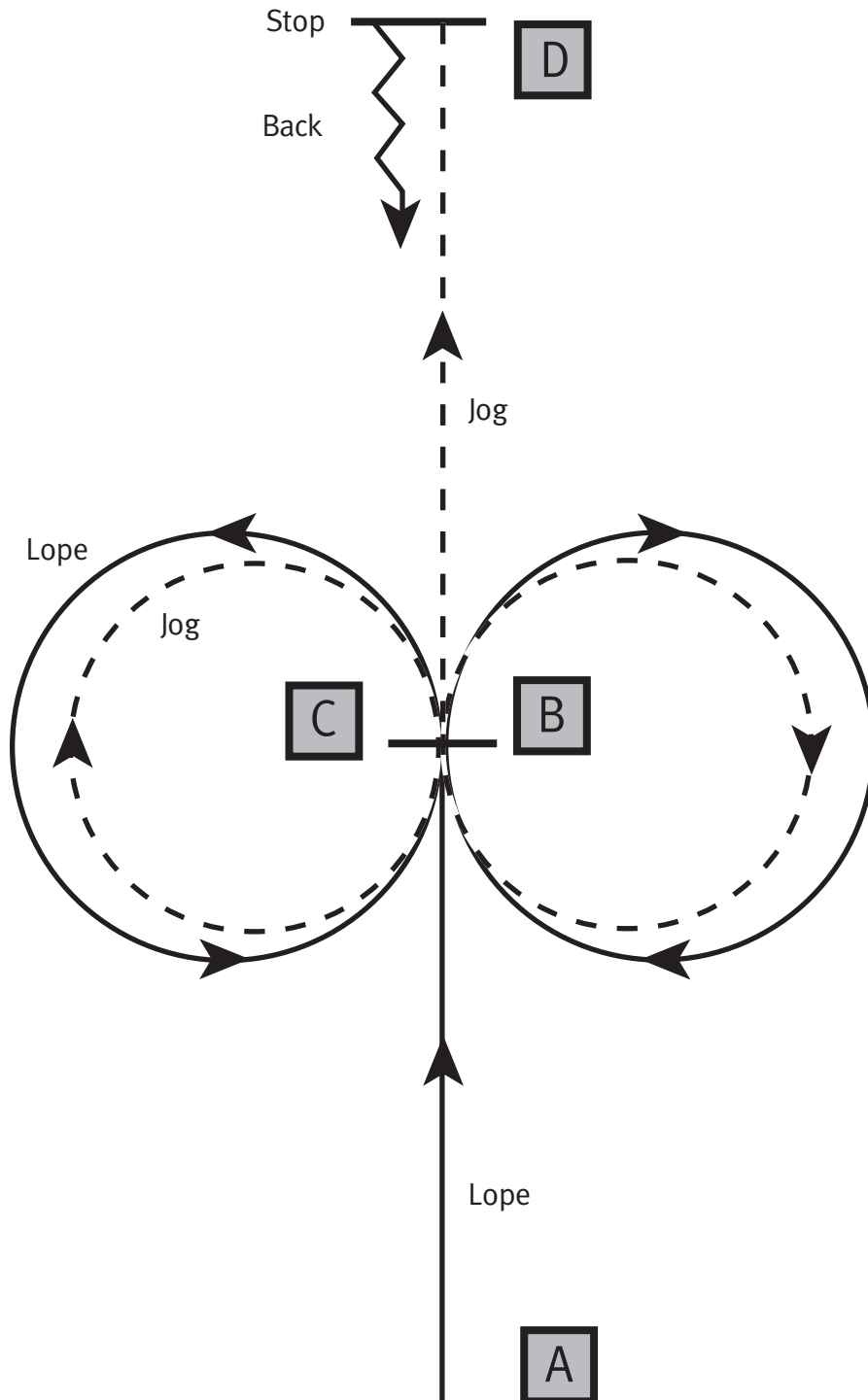

Be ready at marker A.

Lope on the left lead to marker B.

Continue at the lope and lope a figure eight beginning to the left, demonstrating a simple change of lead (walk or jog). Stop.

Jog a figure eight beginning to the left. Continue jogging to marker D.

Stop.

Back ten feet.

Return to the lineup at the jog or exit the arena at the jog.

	Stop / Halt
	Lope
	Jog
	Walk
	Back
	Marker
	Lineup

*This pattern is appropriate to use for all age groups*

*If used at a Regional or National Show, pattern may not be run from the lineup.*

# Western Horsemanship

## LEVEL 1 • PATTERN P

The drawn description of this pattern is only intended for the general depiction of the pattern. Exhibitors should utilize the arena to best exhibit their horses.

- Be ready at marker A.
- Lope right lead to marker B and stop.
- Execute a 360-degree turn on hindquarters right.
- Lope left lead to marker C and stop.
- Execute a 360-degree turn on the hindquarters left.
- Jog to marker D and Stop. Back ten steps.
- Return to the lineup at the jog or exit the arena at the jog.

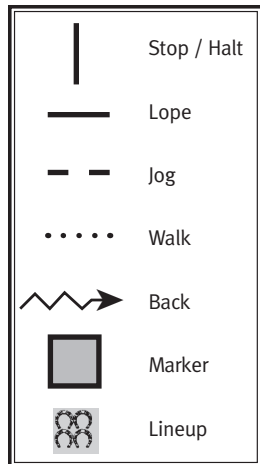

This pattern is appropriate to use for all age groups

If used at a Regional or National Show, pattern may not be run from the lineup.

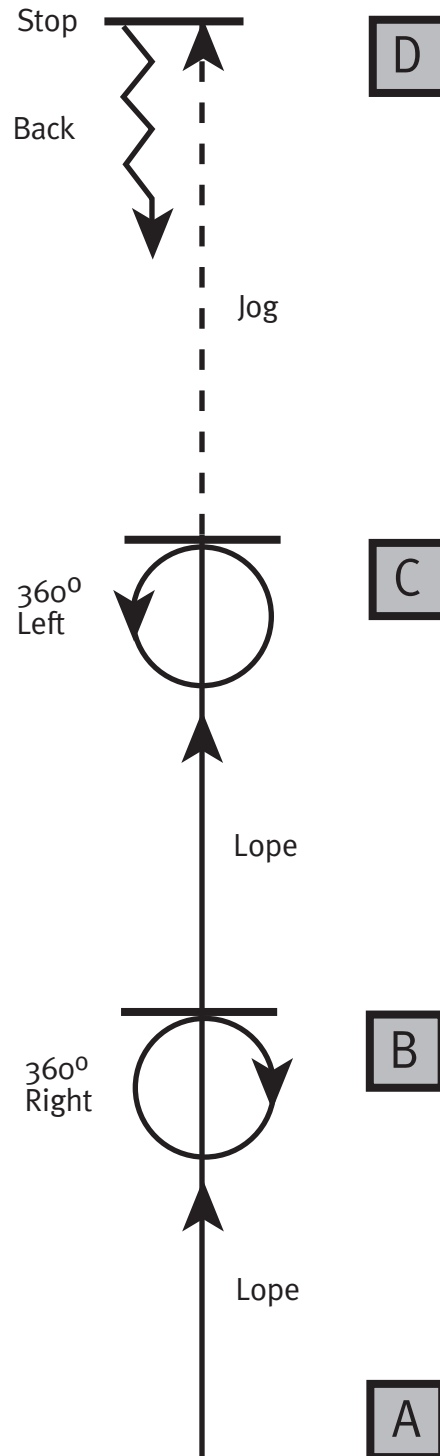

# Western Horsemanship

## LEVEL 1 • PATTERN Q

The drawn description of this pattern is only intended for the general depiction of the pattern. Exhibitors should utilize the arena to best exhibit their horses.

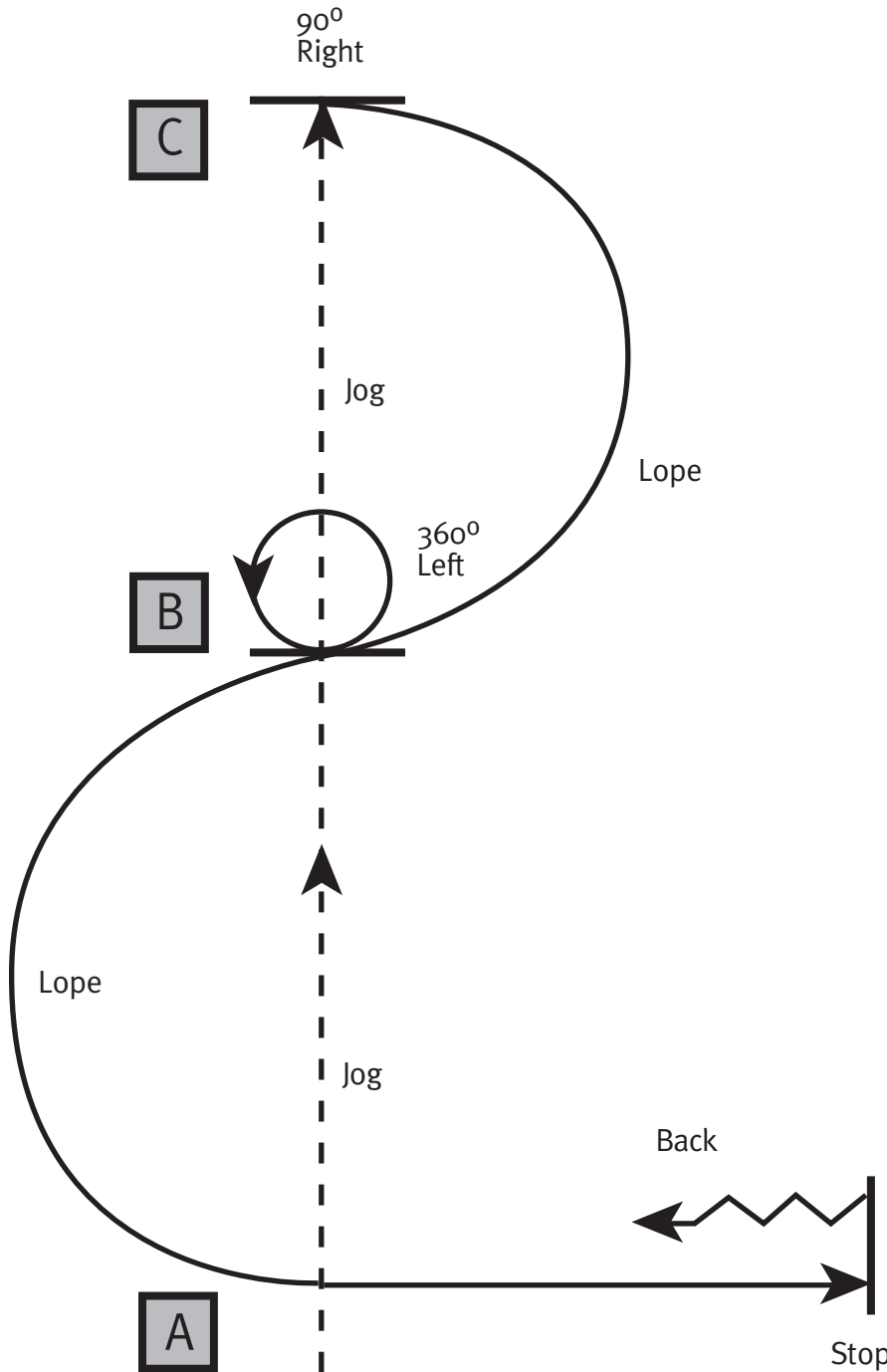

Be ready at marker A.

Jog to marker B. Stop.

Complete a 360-degree turn to the left on the hindquarters.

Jog from marker B to marker C. Stop.

Make a 90-degree turn to the right on the haunches.

Lope a serpentine starting on the right lead.

At marker B demonstrate a simple change of lead (walk or jog) and finish the serpentine at the lope past marker A to the rail. Stop. Back five steps.

Return to the lineup at the jog or exit the arena at the jog.

	Stop / Halt
	Lope
	Jog
	Walk
	Back
	Marker
	Lineup

This pattern is appropriate to use for all age groups

If used at a Regional or National Show, pattern may not be run from the lineup.

# Western Horsemanship

## LEVEL 1 • PATTERN R

The drawn description of this pattern is only intended for the general depiction of the pattern. Exhibitors should utilize the arena to best exhibit their horses.

Be ready at marker A.

Lope a two loop serpentine, beginning on the right lead, with a simple lead change (walk or jog) from marker A to marker B. Stop.

Perform a 450-degree turn on the haunches right.

Jog to a point half way between marker B and marker C and execute a figure eight at the jog (starting either direction), continue to marker C. Stop.

Back ten steps.

Perform a 450-degree turn on the haunches left.

Return to lineup at the jog or exit arena at the jog.

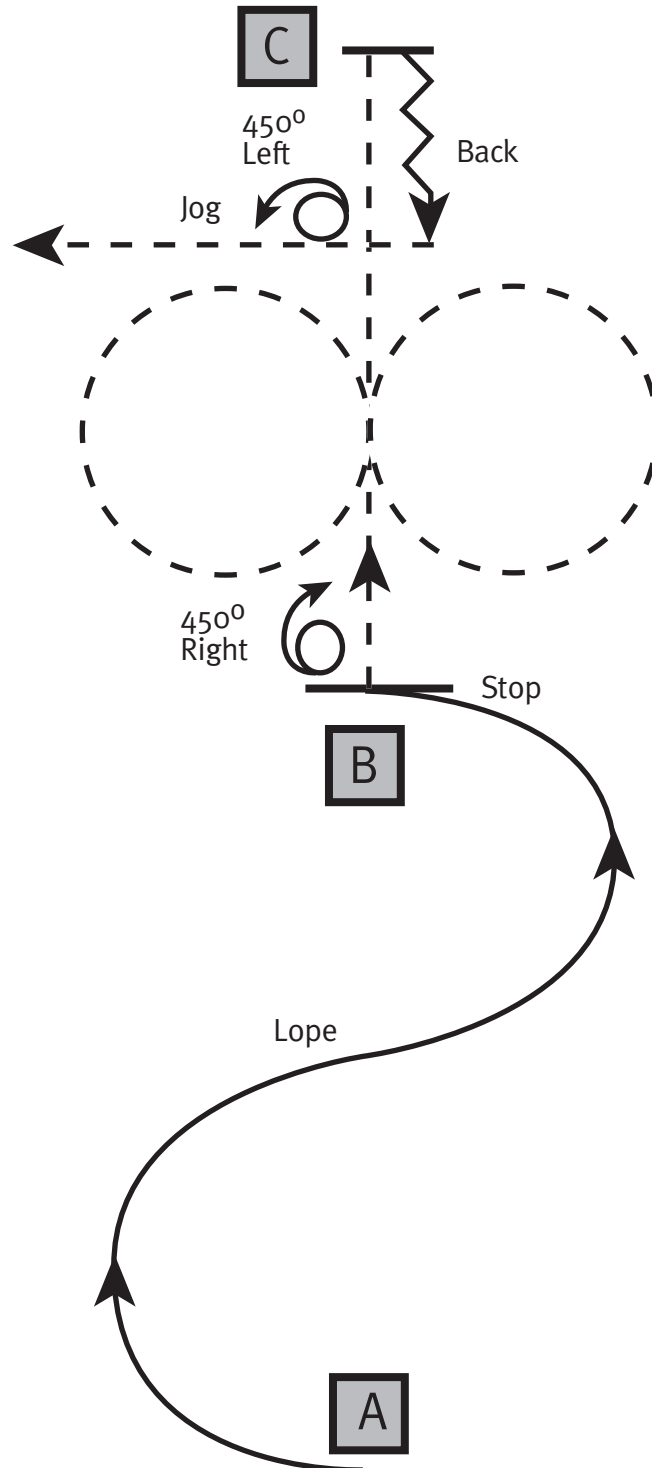
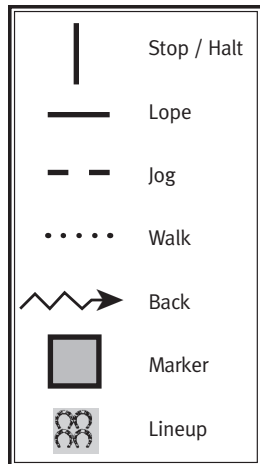

This pattern is appropriate to use for all age groups

If used at a Regional or National Show, pattern may not be run from the lineup.



# Western Horsemanship

## LEVEL 1 • PATTERN T

The drawn description of this pattern is only intended for the general depiction of the pattern. Exhibitors should utilize the arena to best exhibit their horses.

Be ready at marker A.

Jog to middle.

Stop, 360-degree turn to the left on the haunches.

Lope a circle on the left lead.

Simple change of lead through walk or jog.

Lope right lead, break to jog.

Stop and back.

Return to lineup at the jog or exit arena at the jog.

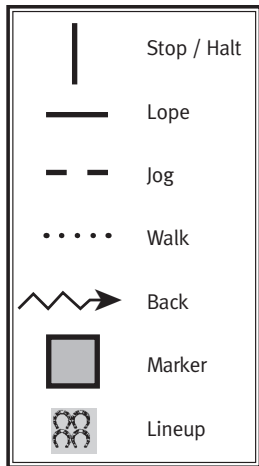

This pattern is appropriate to use for all age groups

If used at a Regional or National Show, pattern may not be run from the lineup.

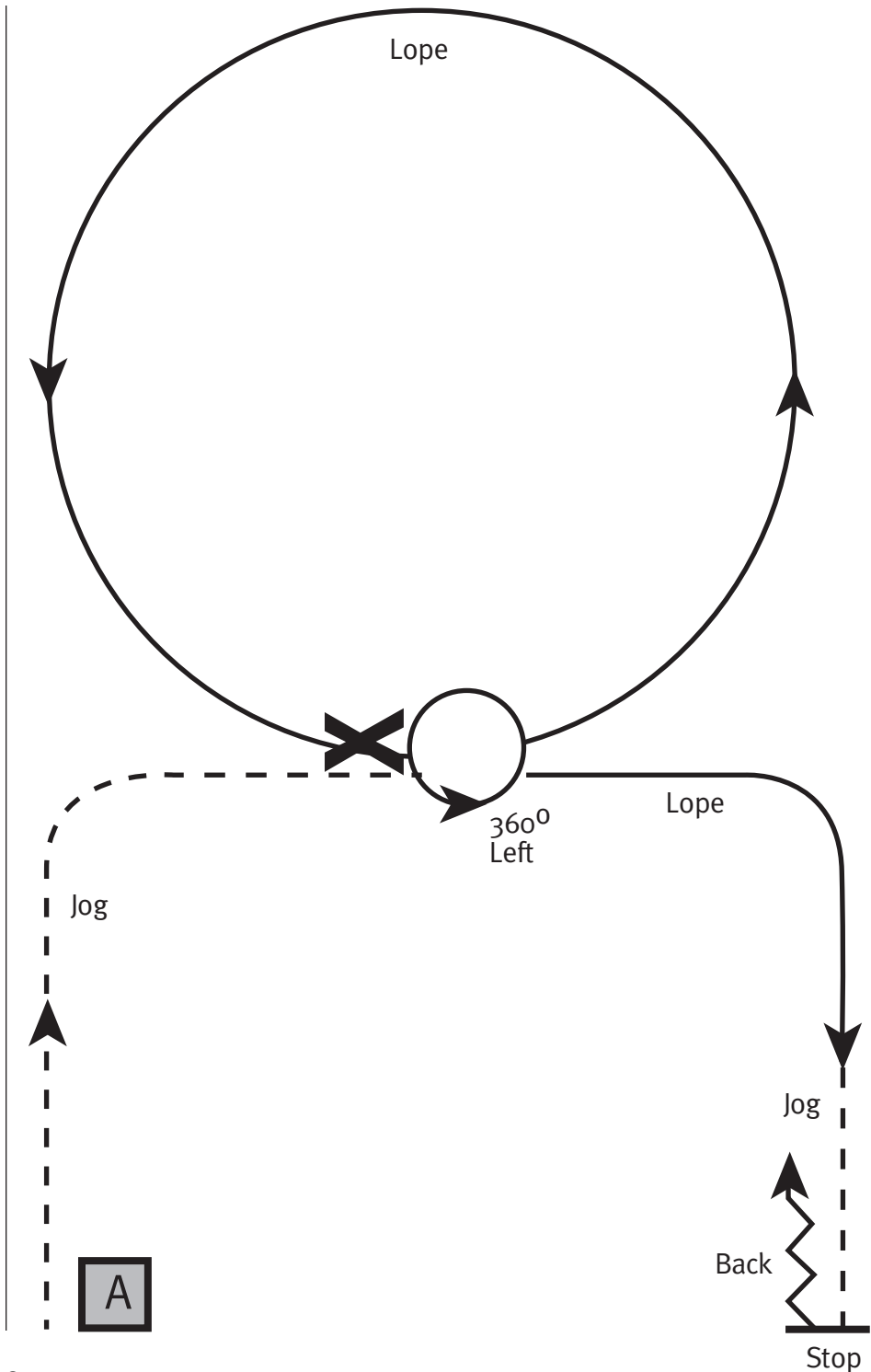

# WESTERN HORSEMANSHIP

---

## Level 2

The following patterns are appropriate  
for ALL ages

# Western Horsemanship

## LEVEL 2 • PATTERN W

The drawn description of this pattern is only intended for the general depiction of the pattern. Exhibitors should utilize the arena to best exhibit their horses.

Be ready at marker A.

Walk from marker A to marker B.

Jog to marker C.

Lope on the left lead to marker D.

Extended lope a circle on the left lead around marker D and continue to marker E. Stop.

Execute a 180-degree turn on haunches to the left.

Execute a 180-degree turn on haunches to the right.

Back four steps.

Return to the lineup at the jog or exit arena at the jog.

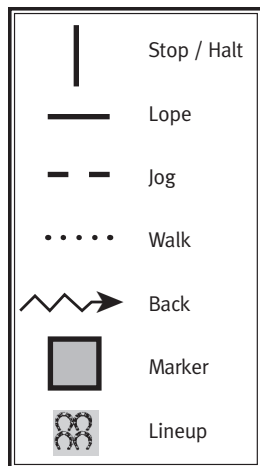

This pattern is appropriate to use for all age groups

If used at a Regional or National Show, pattern may not be run from the lineup.

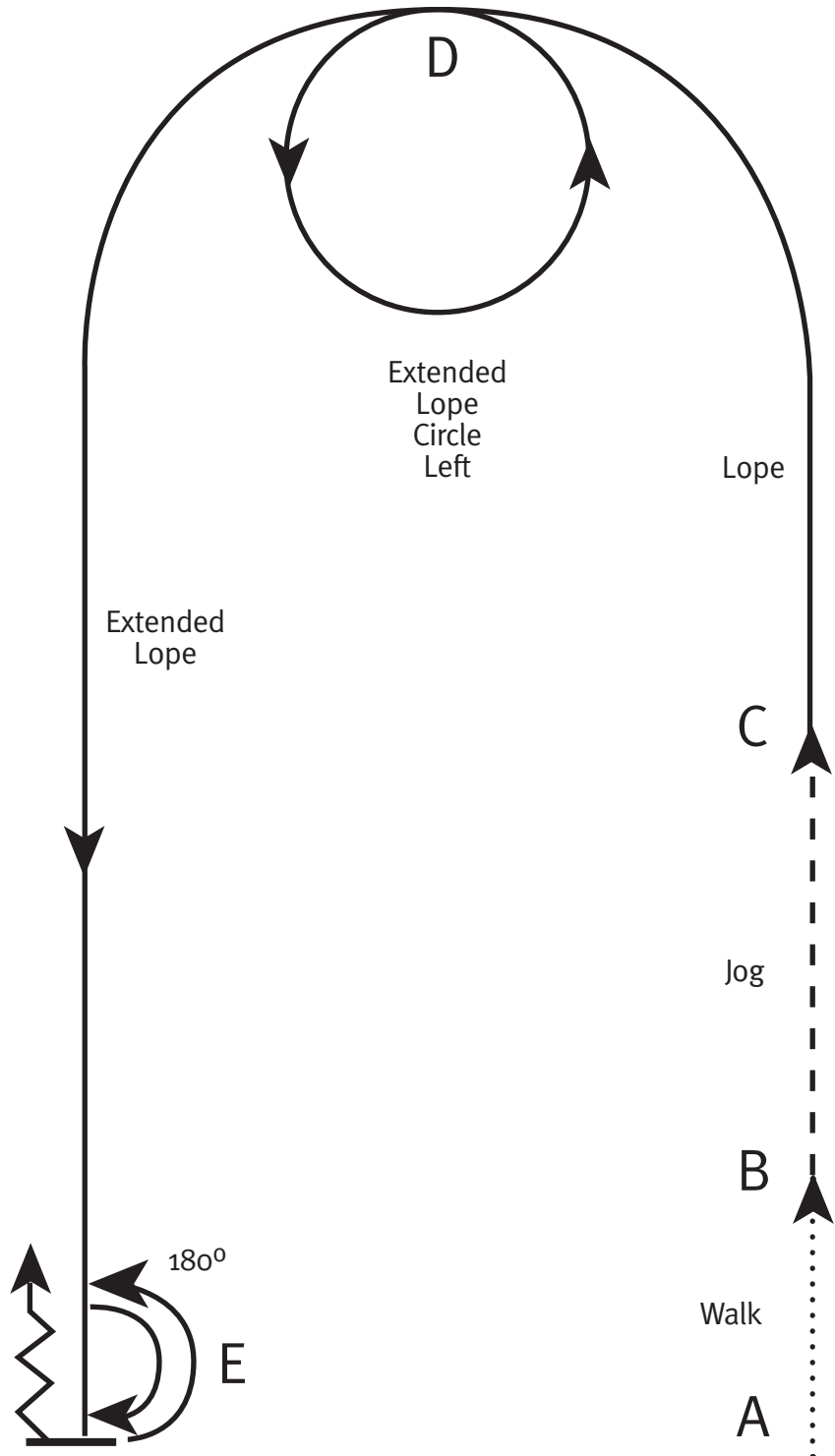



# Western Horsemanship

## LEVEL 2 • PATTERN EE

The drawn description of this pattern is only intended for the general depiction of the pattern. Exhibitors should utilize the arena to best exhibit their horses.

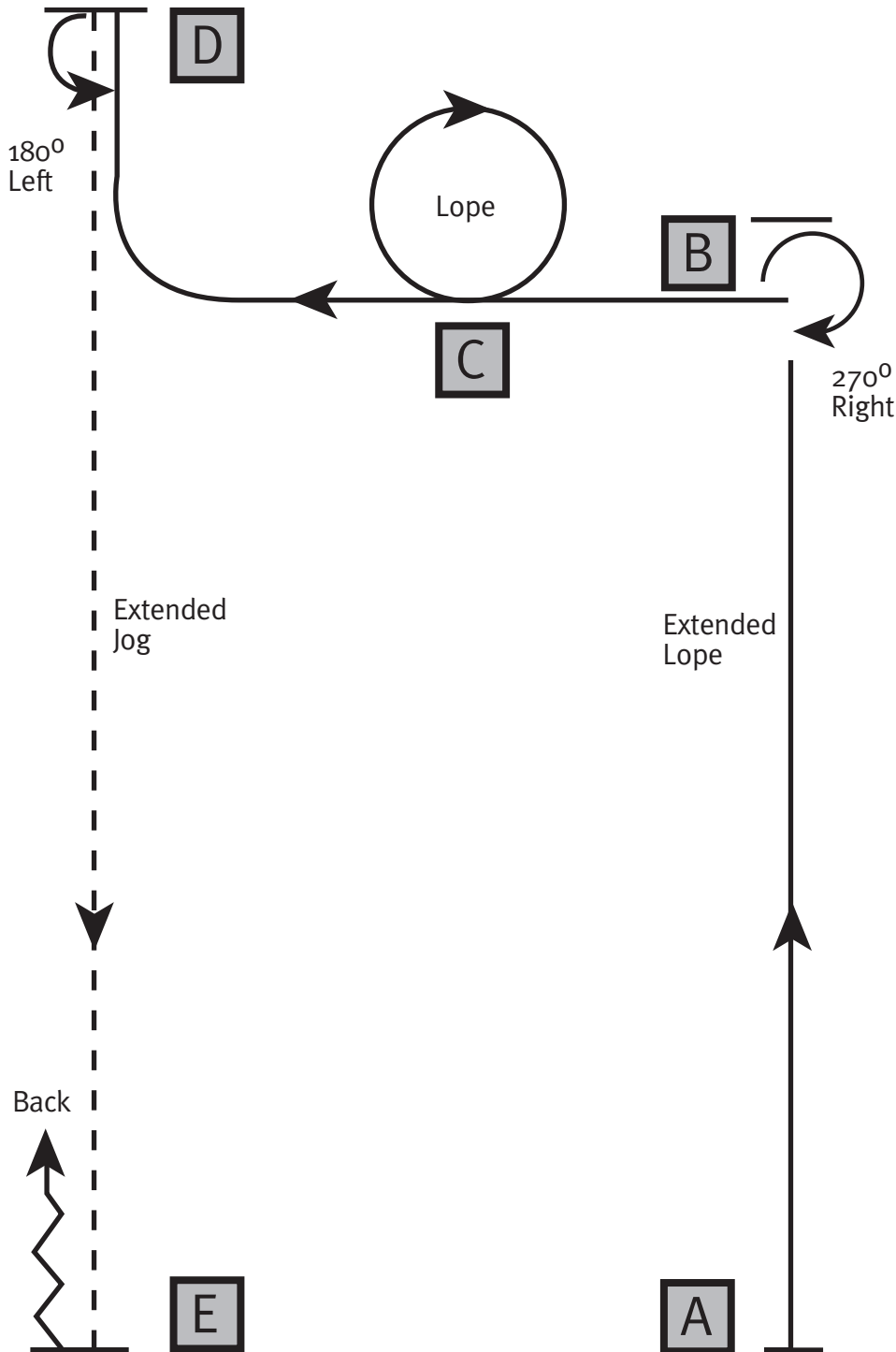

Be ready at A.

Extended lope on the left lead to B and stop.

Execute 270-degree turn to the right.

Lope on the right lead to C, continuing at the lope make a small circle continuing to D and stop.

Execute a 180-degree turn to the left.

Extended jog to E. Stop and back ten feet.

Return to lineup at the jog or exit arena at the jog.

	Stop / Halt
	Lope
	Jog
	Walk
	Back
	Marker
	Lineup

This pattern is appropriate to use for all age groups

If used at a Regional or National Show, pattern may not be run from the lineup.

# Western Horsemanship

## LEVEL 2 • PATTERN MM

The drawn description of this pattern is only intended for the general depiction of the pattern. Exhibitors should utilize the arena to best exhibit their horses.

Be ready at marker A.

Lope on the left lead to marker B.

Walk from marker B to marker C.

Lope on the right lead to marker D.

Execute a large circle to the right on the right lead at the extended lope.

Execute a small circle to the right at the lope on the right lead.

Stop at marker D and execute a 180-degree turn on the haunches to the left.

Extend the jog to marker B.

Stop at marker B and back to marker C.

Return to lineup at the jog or exit the arena at the jog.

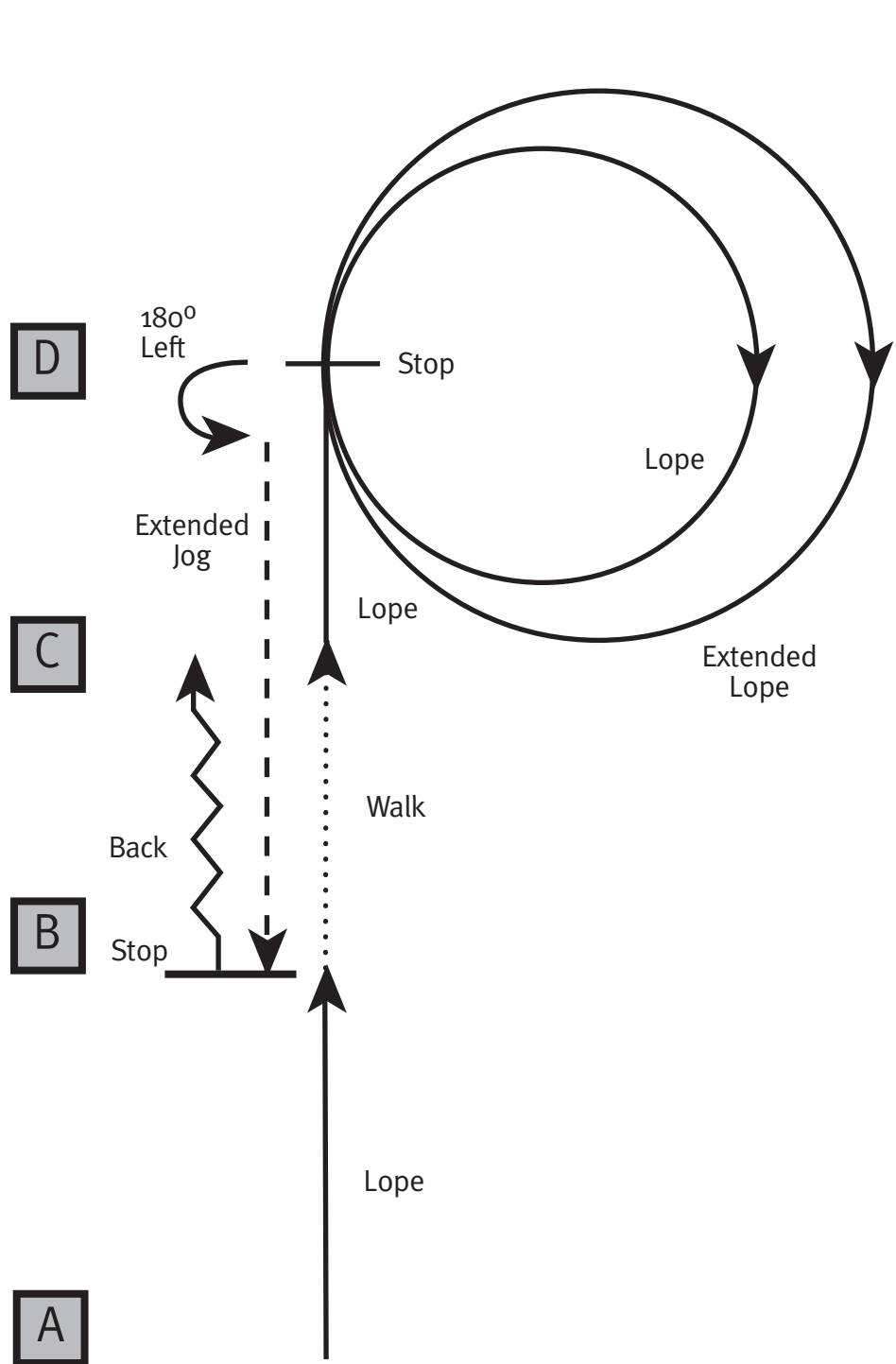
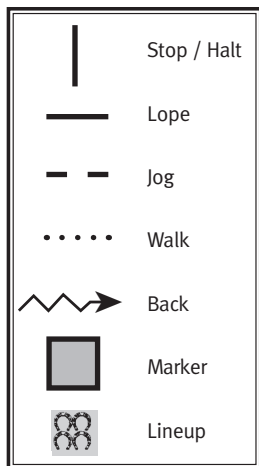

This pattern is appropriate to use for all age groups

If used at a Regional or National Show, pattern may not be run from the lineup.

# Western Horsemanship

## LEVEL 2 • PATTERN QQ

*The drawn description of this pattern is only intended for the general depiction of the pattern. Exhibitors should utilize the arena to best exhibit their horses.*

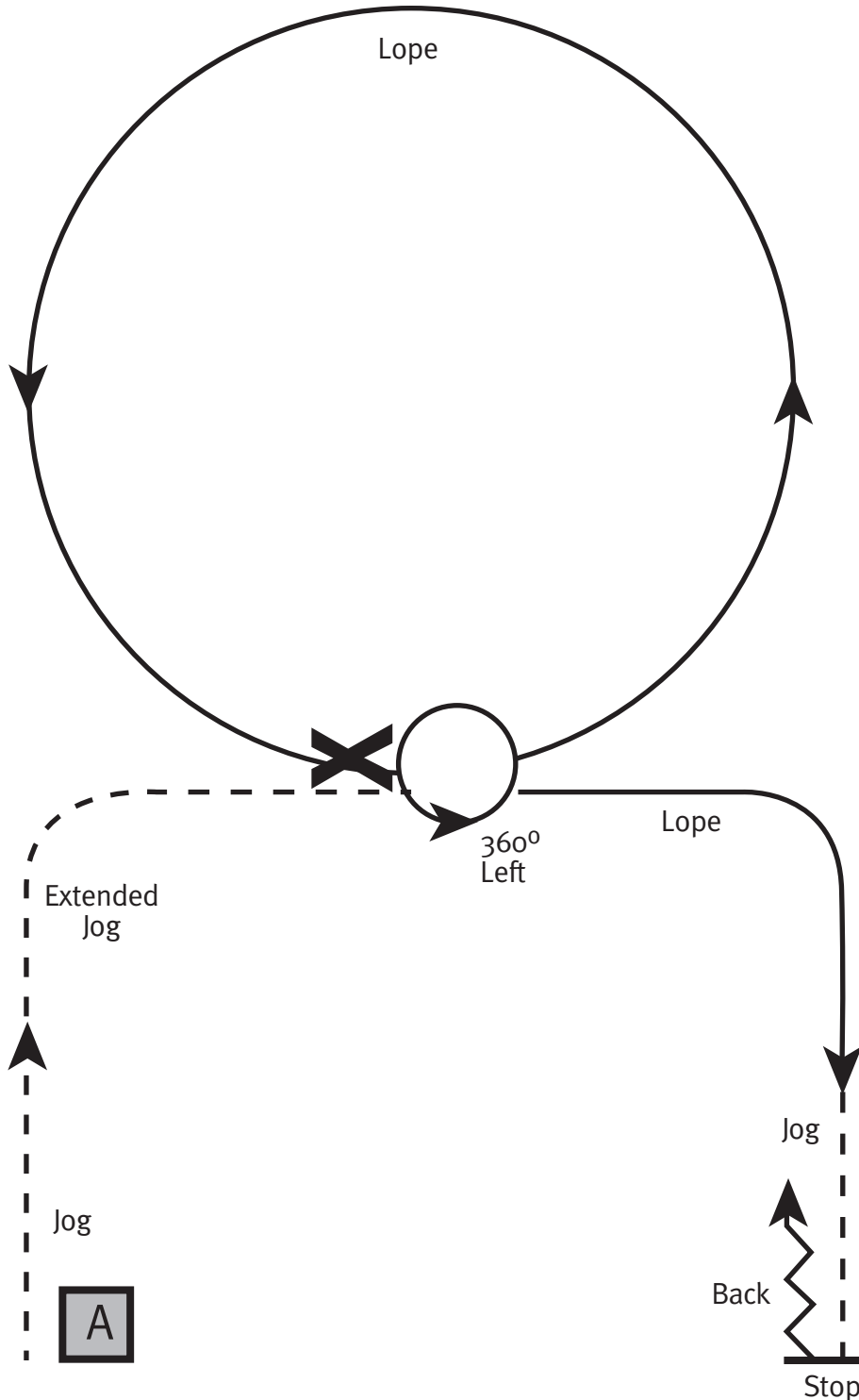

Be ready at marker A.

Jog 1/2 line, extend jog to middle.

Stop, 360-degree turn to the left on the haunches.

Lope a circle on the left lead.

Simple change of lead through walk or jog.

Lope right lead, break to jog.

Stop and back.

Return to lineup at the jog or exit arena at the jog.

	Stop / Halt
	Lope
	Jog
	Walk
	Back
	Marker
	Lineup

*This pattern is appropriate to use for all age groups*

*If used at a Regional or National Show, pattern may not be run from the lineup.*

# Western Horsemanship

## LEVEL 2 • PATTERN BBB

The drawn description of this pattern is only intended for the general depiction of the pattern. Exhibitors should utilize the arena to best exhibit their horses.

Be ready at marker A.

Lope, right lead.

Jog.

Lope, left lead.

Walk.

Stop, back.

Execute a 270-degree turn to the right on the haunches.

Jog.

Extended jog, stop when even with cone A.

Return to line up or exit arena as directed by ringmaster.

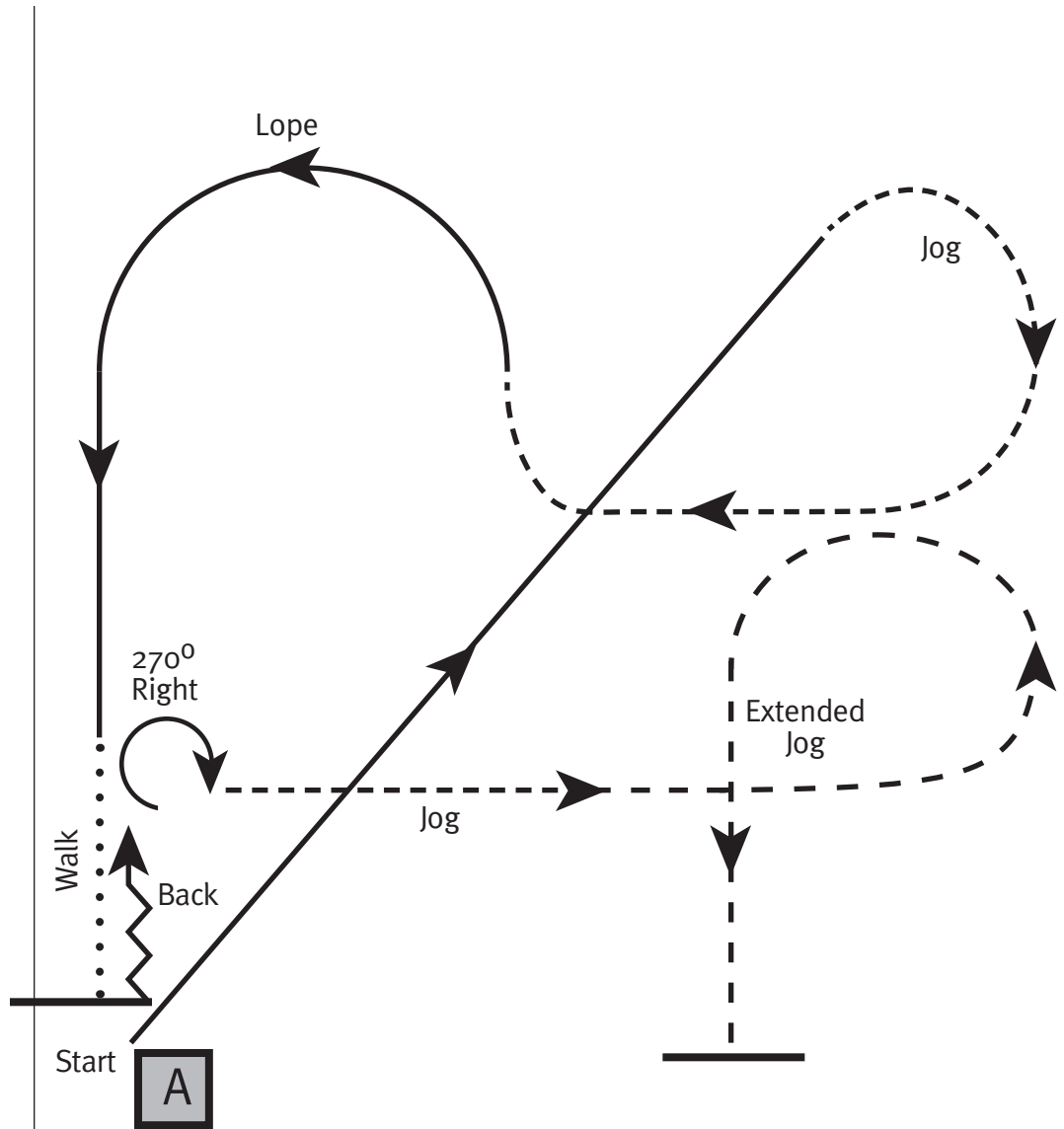
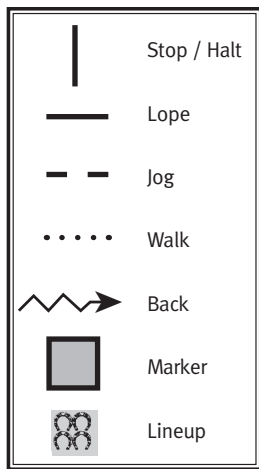

This pattern is appropriate to use for all age groups

If used at a Regional or National Show, pattern may not be run from the lineup.

# Western Horsemanship

## LEVEL 2 • PATTERN CCC

*The drawn description of this pattern is only intended for the general depiction of the pattern. Exhibitors should utilize the arena to best exhibit their horses.*

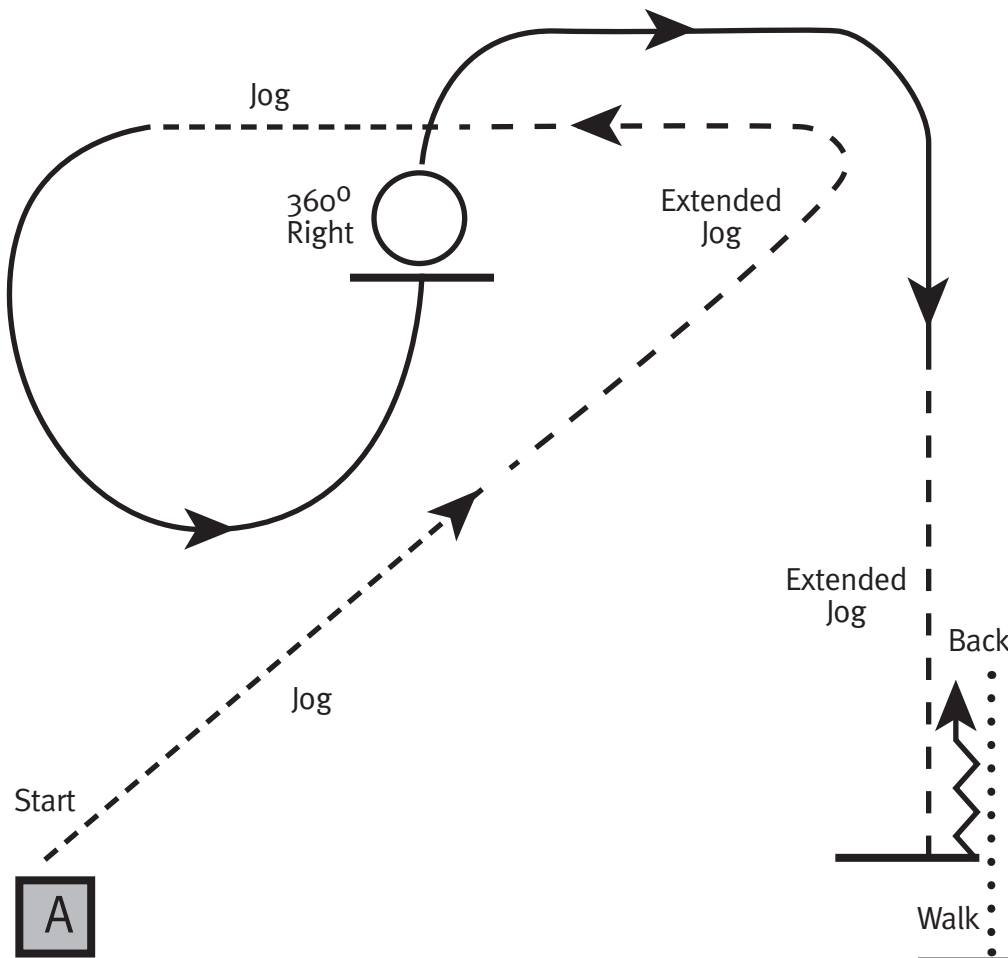

- Be ready at marker A.
- Jog.
- Extended jog.
- Jog.
- Lope, left lead.
- Halt, execute 360-degree turn to the right on the haunches.
- Lope, right lead.
- Extended jog.
- Stop when even with cone A. Back.
- Walk, stop.
- Return to line up or exit arena as directed by ringmaster.

	Stop / Halt
	Lope
	Jog
	Walk
	Back
	Marker
	Lineup

*This pattern is appropriate to use for all age groups*

*If used at a Regional or National Show, pattern may not be run from the lineup.*

# WESTERN HORSEMANSHIP

---

## Level 2

The following patterns may only be used for:

- 14 - 18
- 18 & Under
- 19 & Over

# Western Horsemanship

## LEVEL 2 • PATTERN U

The drawn description of this pattern is only intended for the general depiction of the pattern.  
 Exhibitors should utilize the arena to best exhibit their horses.

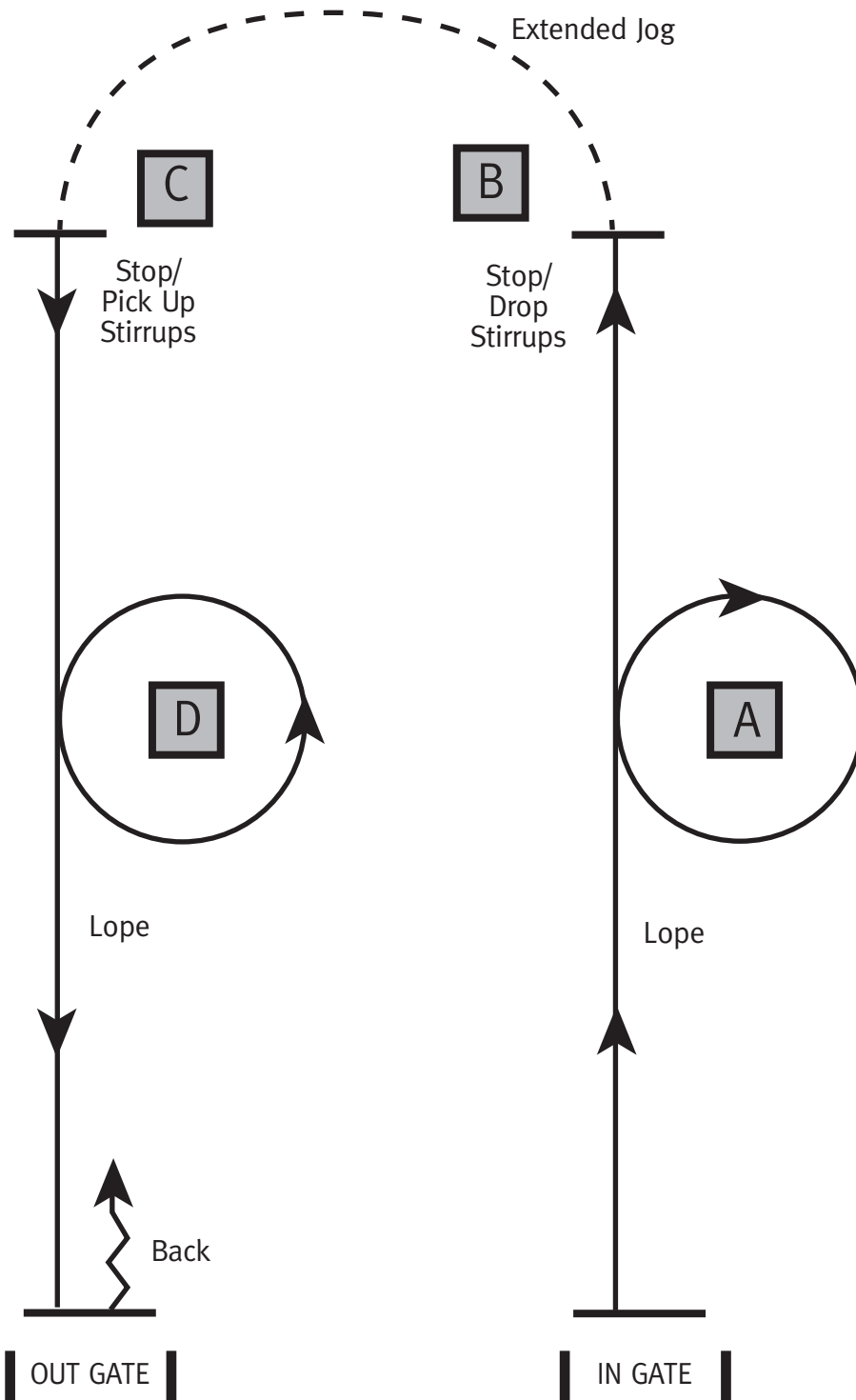

- Be ready at in-gate.
- Lope on right lead.
- Lope circle around marker A on right lead.
- At marker B, stop and drop stirrups.  
Extended jog around to marker C.
- At marker C, stop and pick up stirrups.
- Pick up a lope on the left lead.
- Lope a circle around marker D on the left lead.
- Stop and back about ten feet.
- Return to lineup at the jog or exit arena at the jog.

	Stop / Halt
	Lope
	Jog
	Walk
	Back
	Marker
	Lineup

This pattern may only be used for:

- 14 - 18
- 18 & Under
- 19 & Over

This pattern may **NOT** be used for:

- 13 & Under
- 14 & Under

If used at a Regional or National Show, pattern may not be run from the lineup.

# Western Horsemanship

## LEVEL 2 • PATTERN V

The drawn description of this pattern is only intended for the general depiction of the pattern. Exhibitors should utilize the arena to best exhibit their horses.

Be ready at marker A. Walk to marker B.

Jog to marker C.

Lope a half circle to marker D as drawn on the left lead.

Stop at marker D and execute a 180-degree turn on the hindquarters right.

Lope a half circle to marker C on the right lead.

Stop at marker C, drop your stirrups and jog to marker A.

Stop at marker A, pick up your stirrups and back ten steps.

Return to lineup at the jog or exit arena at the jog.

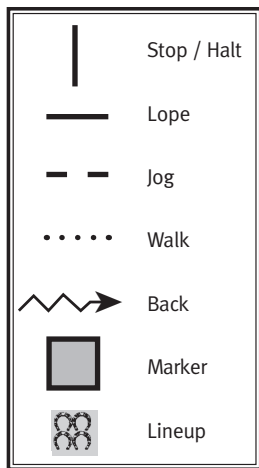

This pattern may only be used for:

- 14 - 18
- 18 & Under
- 19 & Over

This pattern may **NOT** be used for:

- 13 & Under
- 14 & Under

If used at a Regional or National Show, pattern may not be run from the lineup.

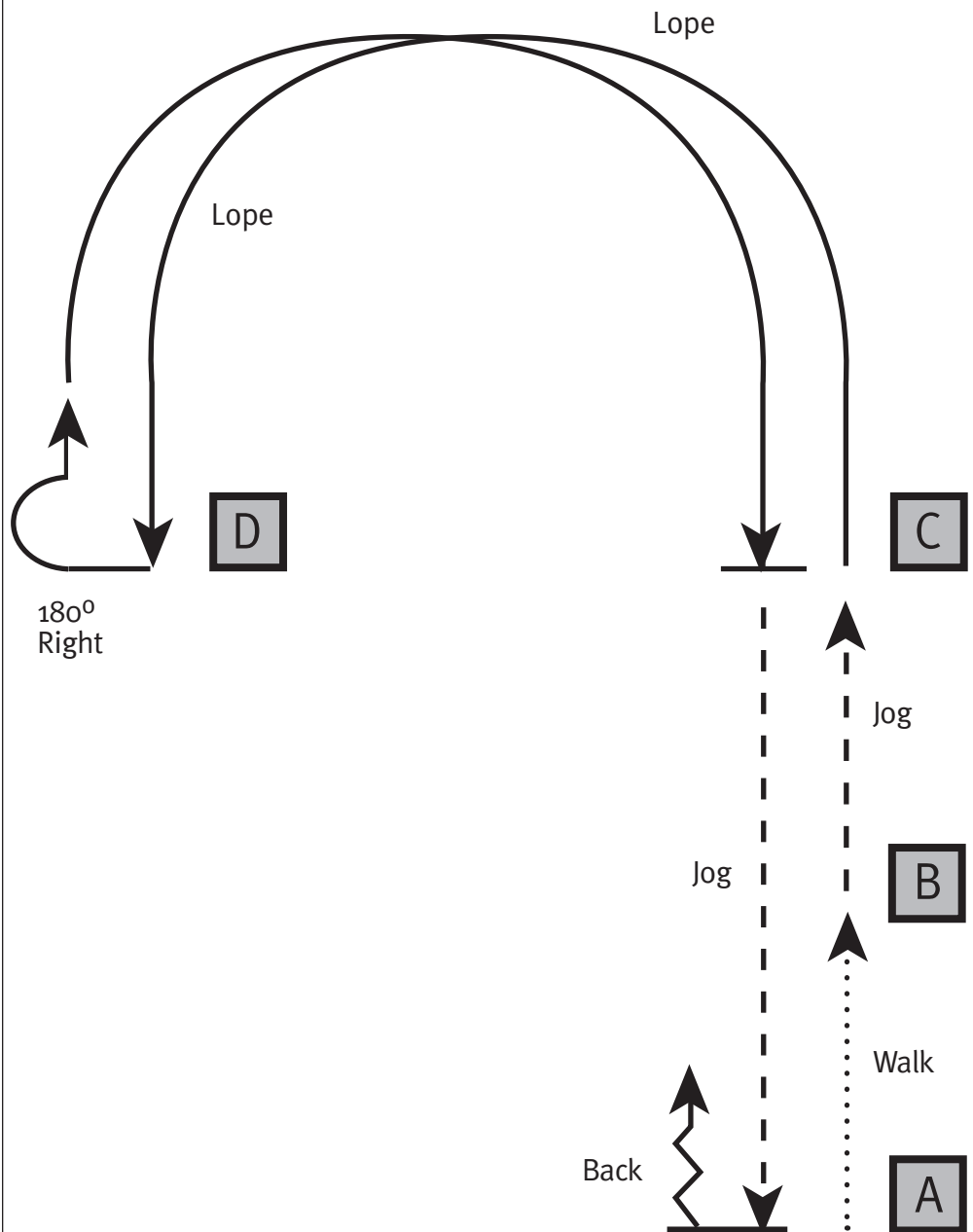



# Western Horsemanship

## LEVEL 2 • PATTERN X

The drawn description of this pattern is only intended for the general depiction of the pattern. Exhibitors should utilize the arena to best exhibit their horses.

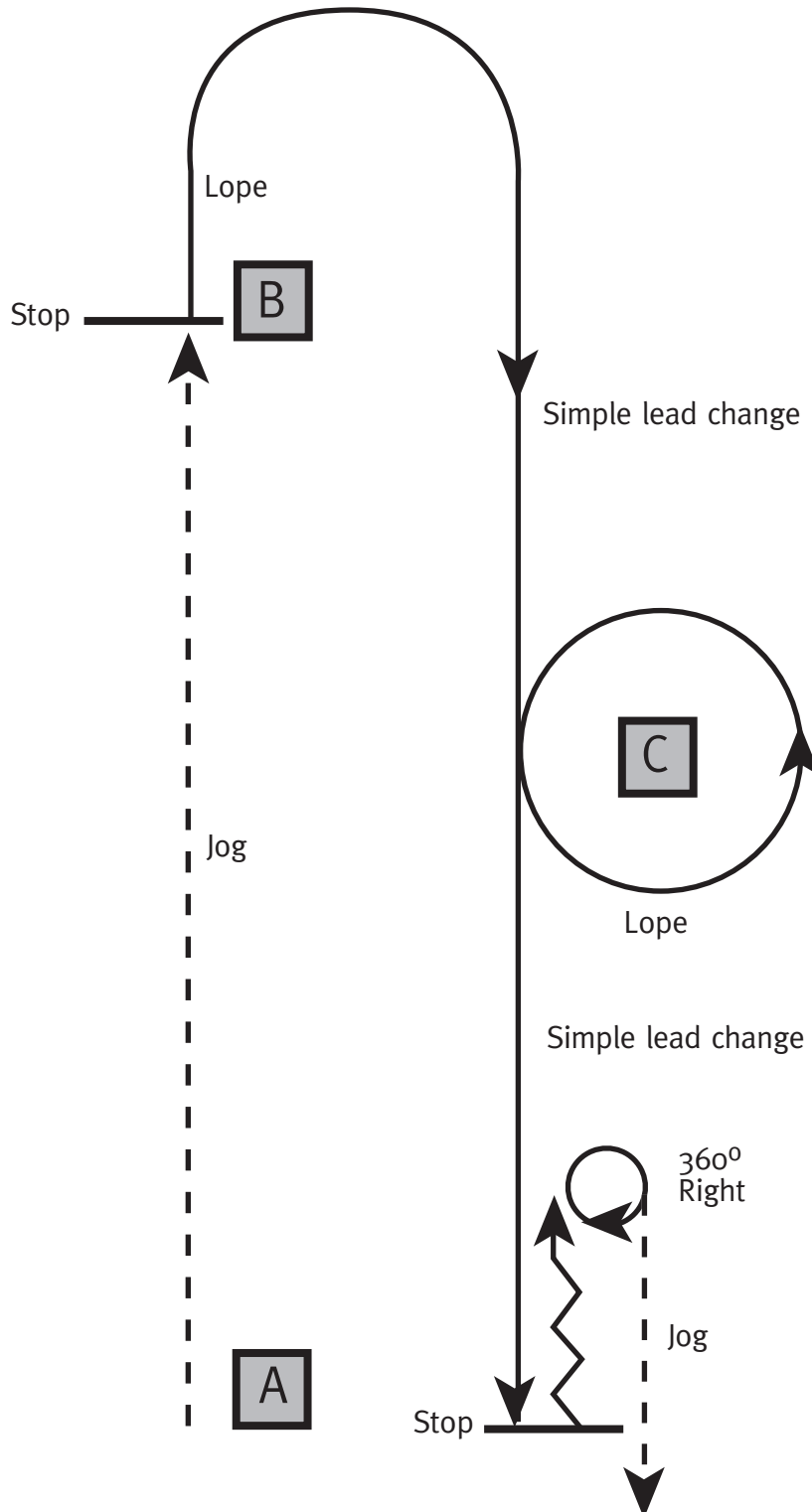

Be ready at marker A.  
 Drop stirrups and jog to marker B.  
 Stop and pick up stirrups.  
 Lope right lead around marker B.  
 Execute a simple lead change (walk or jog) before marker C.  
 Lope a left circle around marker C.  
 After closing circle, execute a simple lead change (walk or jog) and continue lope until you are even with marker A.  
 Stop and back ten steps.  
 Execute a 360-degree turn to the right on the hindquarters.  
 Return to the lineup at the jog or exit the arena at the jog.

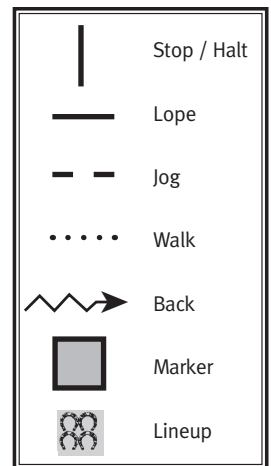

This pattern may only be used for:

- 14 - 18
- 18 & Under
- 19 & Over

This pattern may **NOT** be used for:

- 13 & Under
- 14 & Under

If used at a Regional or National Show, pattern may not be run from the lineup.

# Western Horsemanship

## LEVEL 2 • PATTERN Y

The drawn description of this pattern is only intended for the general depiction of the pattern. Exhibitors should utilize the arena to best exhibit their horses.

Be ready at marker A.

Jog from marker A to marker B.

At marker B, lope a right circle.

Returning to marker B. Stop.

Drop stirrups and jog a circle to the left. Stop.

Pick up stirrups and lope on left lead to marker C.

Stop and back ten steps.

Return to lineup at the jog or exit the arena at the jog.

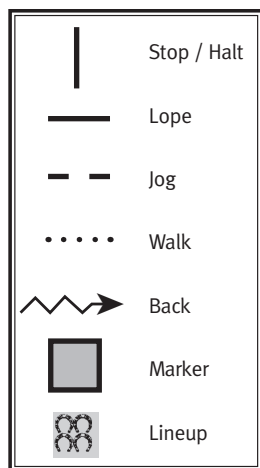

This pattern may only be used for:

- 14 - 18
- 18 & Under
- 19 & Over

This pattern may **NOT** be used for:

- 13 & Under
- 14 & Under

If used at a Regional or National Show, pattern may not be run from the lineup.

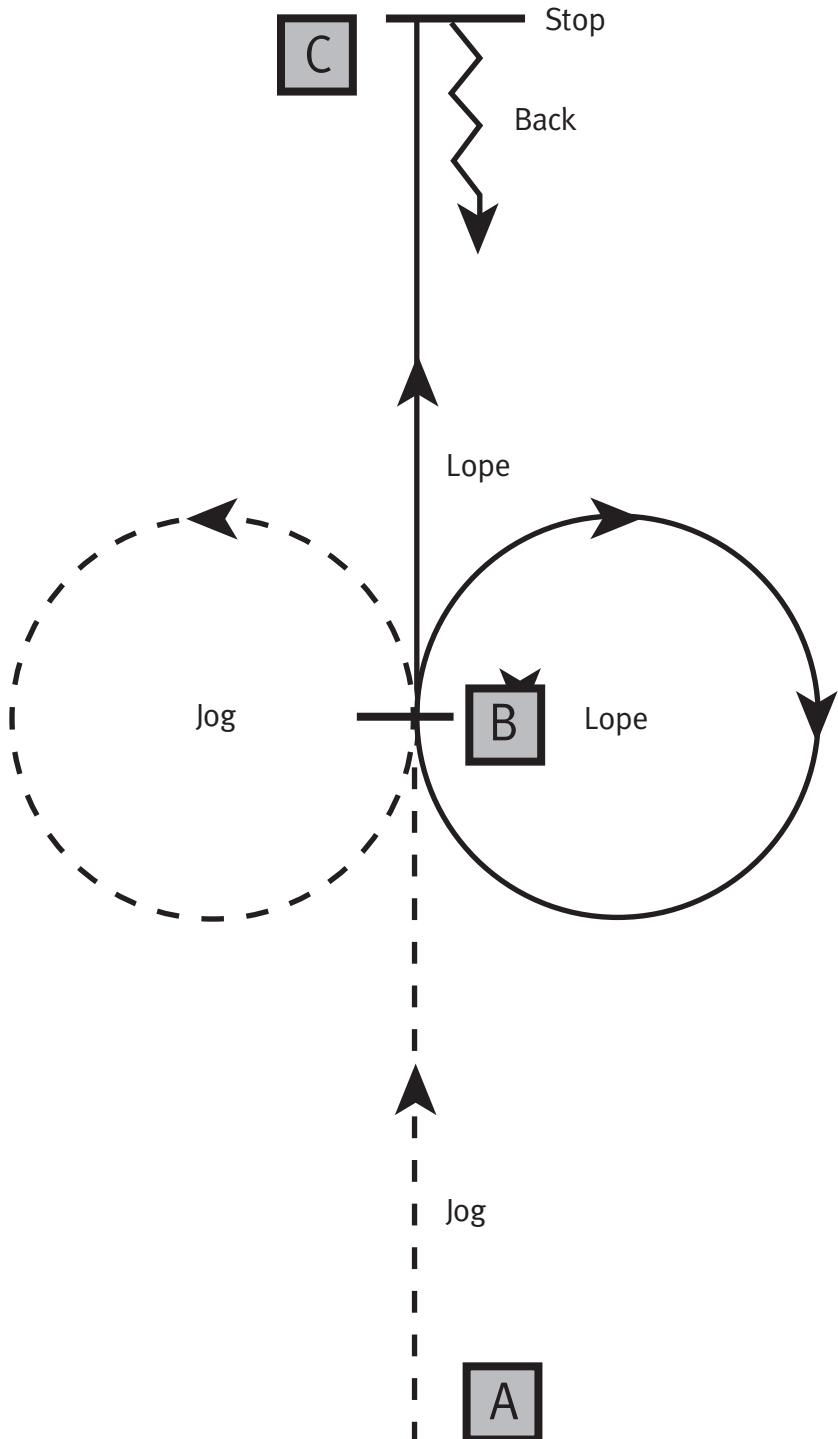

# Western Horsemanship

## LEVEL 2 • PATTERN Z

The drawn description of this pattern is only intended for the general depiction of the pattern. Exhibitors should utilize the arena to best exhibit their horses.

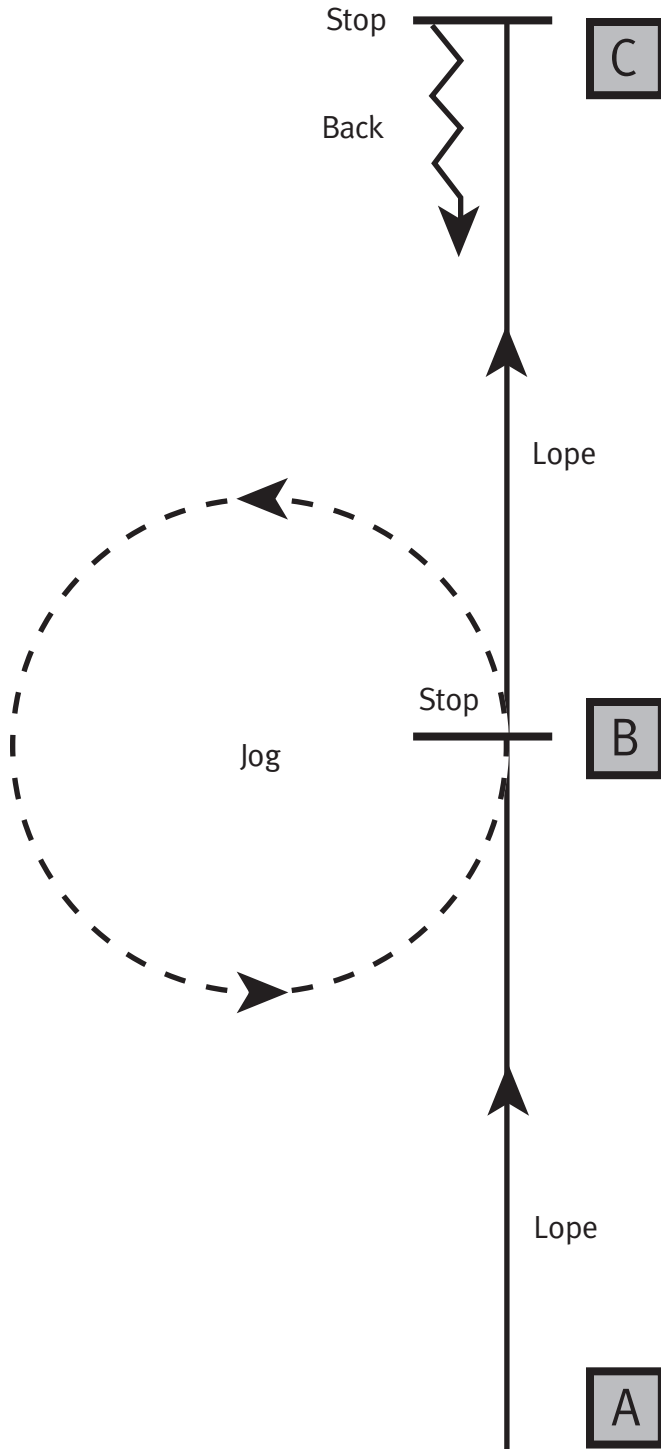

Be ready at marker A.

Lope on the left lead to marker B.  
Stop.

Drop stirrups. Jog a circle to the left and stop. Pick up stirrups.

Lope on the right lead to marker C.

Stop and back four steps.

Return to the lineup at the jog or exit the arena at the jog.

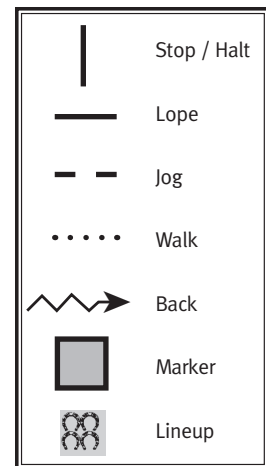

This pattern may only be used for:

- 14 - 18
- 18 & Under
- 19 & Over

This pattern may **NOT** be used for:

- 13 & Under
- 14 & Under

If used at a Regional or National Show, pattern may not be run from the lineup.

# Western Horsemanship

## LEVEL 2 • PATTERN AA

The drawn description of this pattern is only intended for the general depiction of the pattern. Exhibitors should utilize the arena to best exhibit their horses.

Be ready at marker A.

Lope right lead to marker B and stop.

Execute a 360-degree turn on hindquarters right.

Lope left lead to marker C and stop.

Execute a 360-degree turn on the hindquarters left.

Drop stirrups and jog to marker D and Stop. Back ten steps. Pick up stirrups.

Return to the lineup at the jog or exit the arena at the jog.

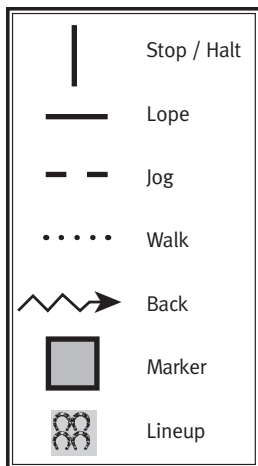

This pattern may only be used for:

- 14 - 18
- 18 & Under
- 19 & Over

This pattern may **NOT** be used for:

- 13 & Under
- 14 & Under

If used at a Regional or National Show, pattern may not be run from the lineup.

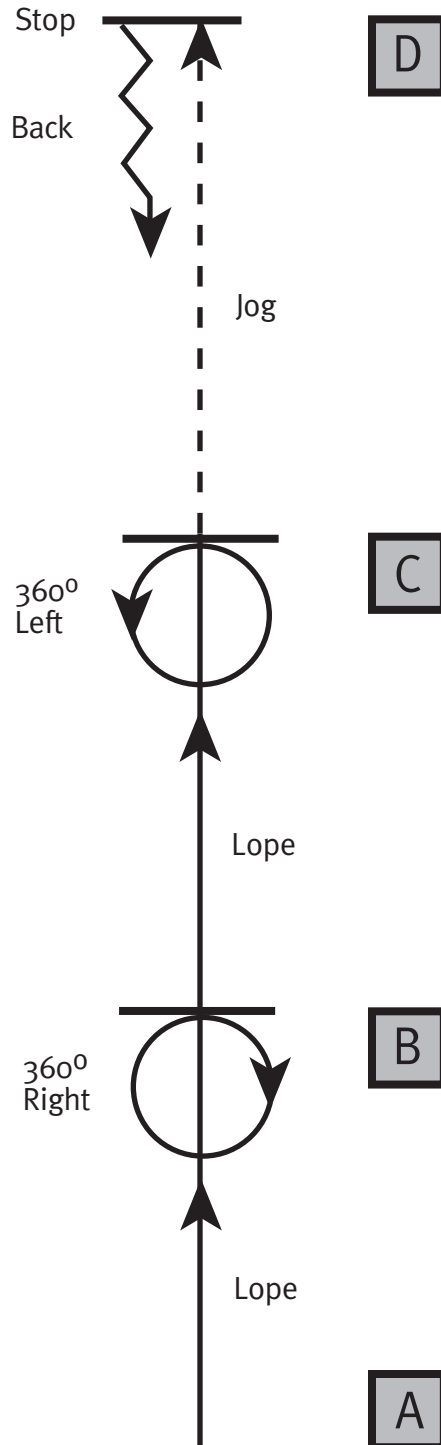

# Western Horsemanship

## LEVEL 2 • PATTERN BB

*The drawn description of this pattern is only intended for the general depiction of the pattern. Exhibitors should utilize the arena to best exhibit their horses.*

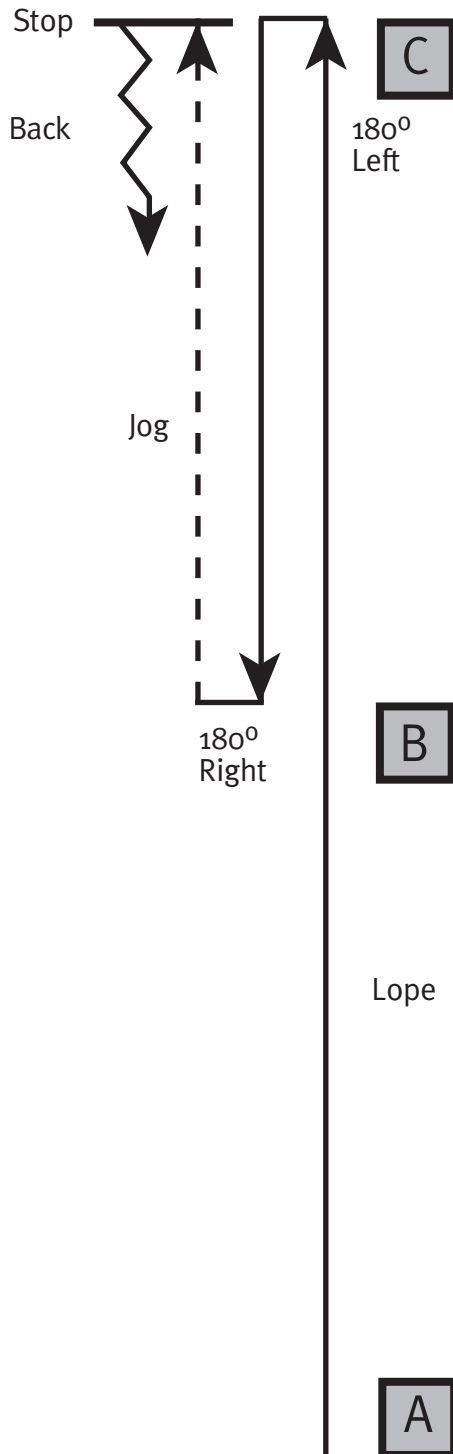

Be ready at marker A.

Lope to marker C on the right lead.

Stop at marker C. Do a 180-degree turn on the haunches to the left.

Lope to marker B on the left lead.

Stop at marker B. Do a 180-degree turn on the haunches to the right.

Drop stirrups. Jog to marker C. Stop and back five steps. Pick up stirrups.

Return to the lineup at the jog or exit the arena at the jog.

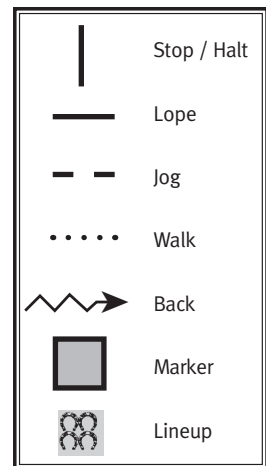

*This pattern may only be used for:*

- 14 - 18
- 18 & Under
- 19 & Over

*This pattern may **NOT** be used for:*

- 13 & Under
- 14 & Under

*If used at a Regional or National Show, pattern may not be run from the lineup.*

# Western Horsemanship

## LEVEL 2 • PATTERN CC

The drawn description of this pattern is only intended for the general depiction of the pattern. Exhibitors should utilize the arena to best exhibit their horses.

Be ready at marker A. Drop stirrups.

Jog to marker B. Stop. Pickup stirrups.

Lope a semi-circle on the right lead to marker C.

Turn 180-degrees on the haunches to the left.

Lope a semi-circle on the left lead to marker B.

Stop.

Back approximately five steps.

Execute the extended jog across the diagonal to marker D. Stop at D.

Return to the lineup at the jog or exit the arena at the jog.

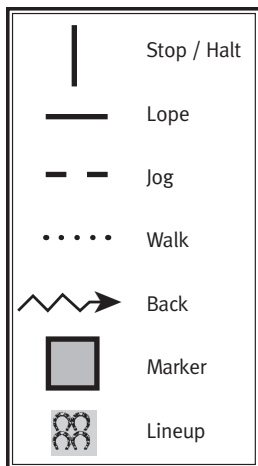

This pattern may only be used for:

- 14 - 18
- 18 & Under
- 19 & Over

This pattern may **NOT** be used for:

- 13 & Under
- 14 & Under

If used at a Regional or National Show, pattern may not be run from the lineup.

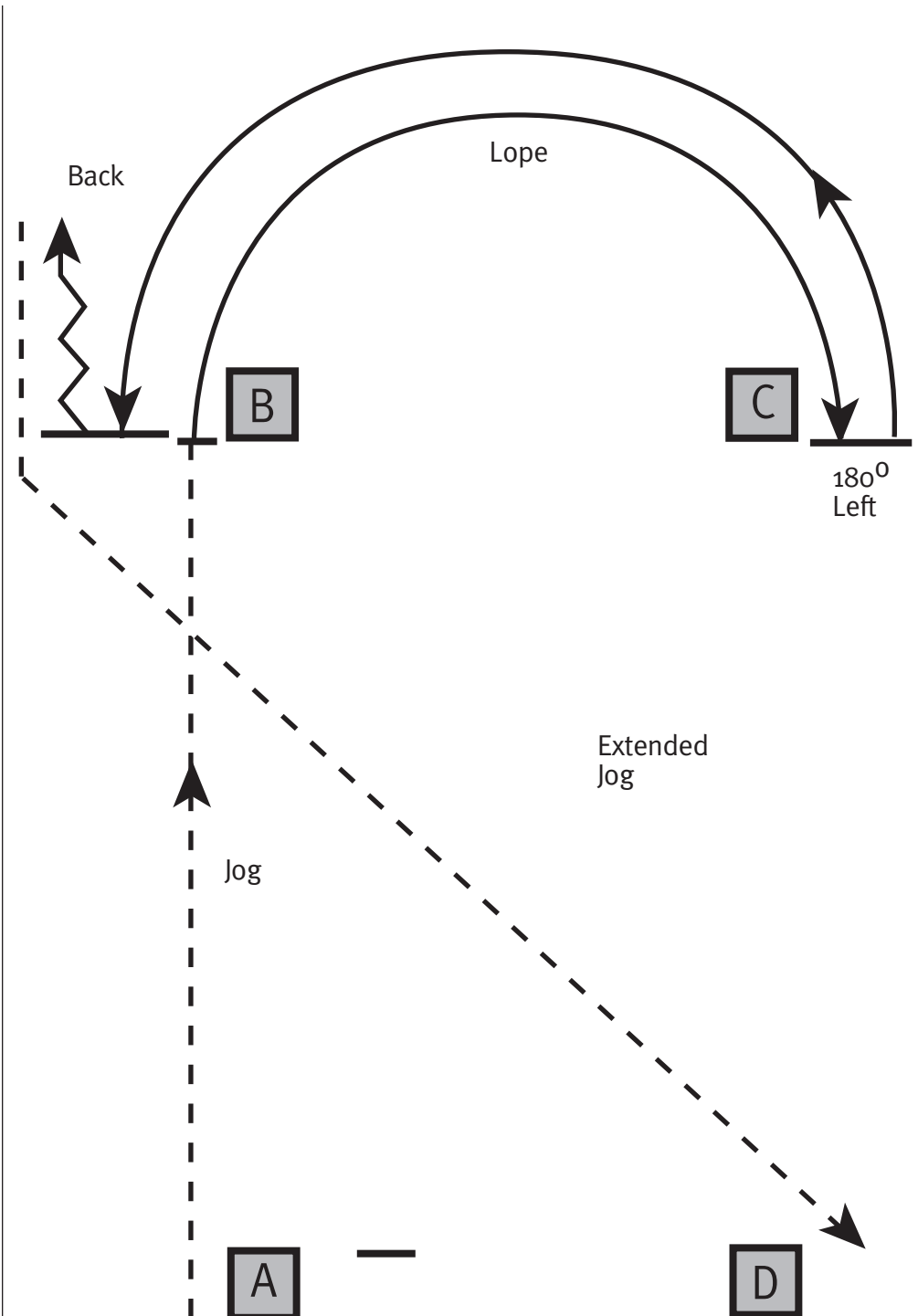



# Western Horsemanship

## LEVEL 2 • PATTERN GG

The drawn description of this pattern is only intended for the general depiction of the pattern. Exhibitors should utilize the arena to best exhibit their horses.

Be ready at marker A.

Lope on the left lead to marker B.

Continue at the lope and lope a figure eight beginning to the left, demonstrating a simple change of lead (walk or jog). Stop.

Drop your stirrups and jog a figure eight beginning to the left. Extend the jog to marker D. Stop.

Pick up stirrups. Back ten feet.

Return to the lineup at the jog or exit the arena at the jog.

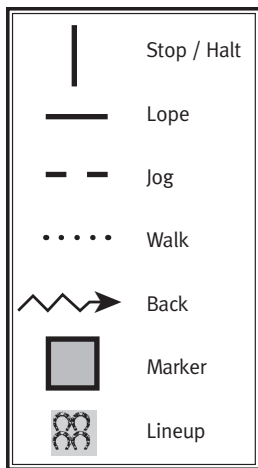

This pattern may only be used for:

- 14 - 18
- 18 & Under
- 19 & Over

This pattern may **NOT** be used for:

- 13 & Under
- 14 & Under

If used at a Regional or National Show, pattern may not be run from the lineup.

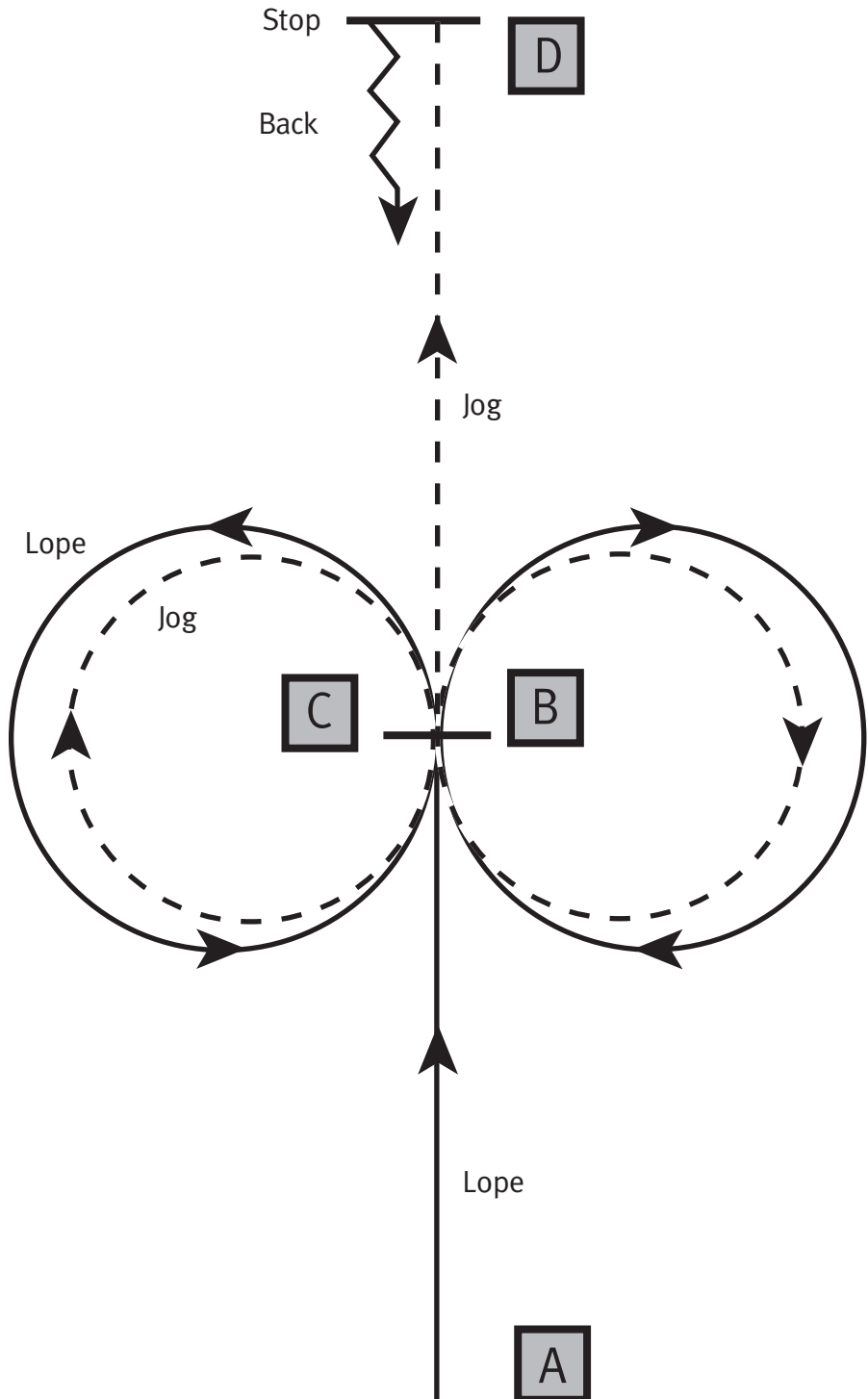



# WESTERN HORSEMANSHIP

---

## Level 3

The following patterns are appropriate  
for ALL ages

# Western Horsemanship

## LEVEL 3 • PATTERN FF

The drawn description of this pattern is only intended for the general depiction of the pattern. Exhibitors should utilize the arena to best exhibit their horses.

Be ready at marker A.

Extended Lope right lead to marker B.

Stop.

Execute a 3/4 turn on the hindquarters to the left.

Extended Lope left lead to marker C.

Stop and back approximately ten feet.

Execute a turn on the forehand.

Return to the lineup at the extended jog or exit arena at the extended jog.

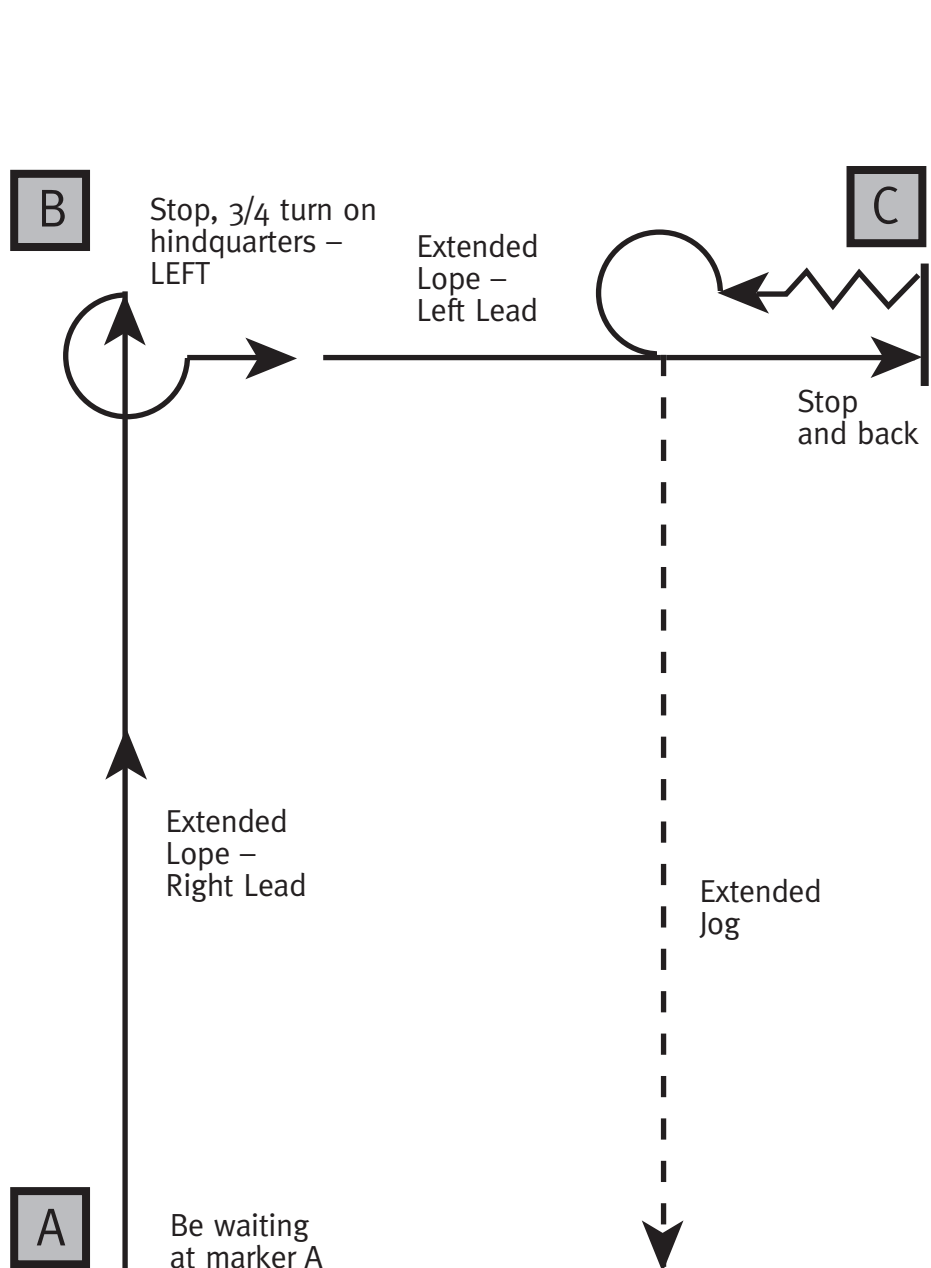
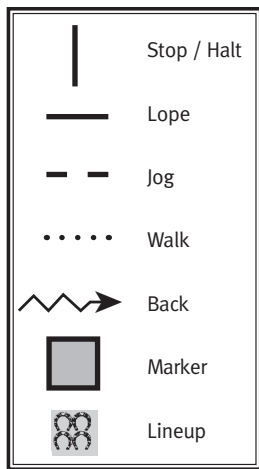

This pattern is appropriate to use for all age groups

If used at a Regional or National Show, pattern may not be run from the lineup.

# Western Horsemanship

## LEVEL 3 • PATTERN HH

The drawn description of this pattern is only intended for the general depiction of the pattern. Exhibitors should utilize the arena to best exhibit their horses.

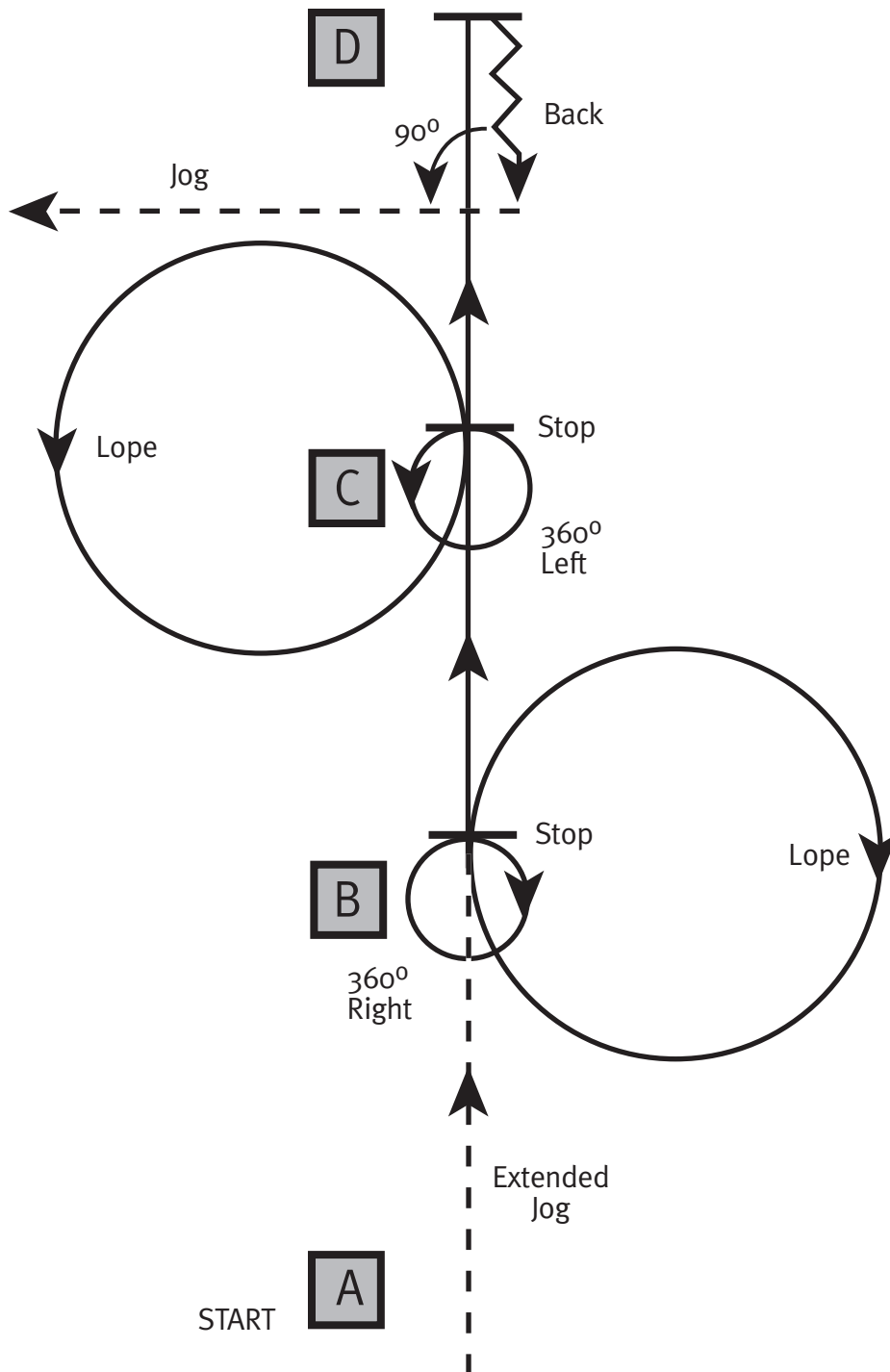

Be ready at marker A. Extended jog from marker A to marker B. Stop.

Execute a 360-degree turn on the haunches right.

Lope a circle on the right lead at marker B and continue to marker C. Stop.

Execute a 360-degree turn on the haunches left.

Lope a circle on the left lead at marker C and continue to marker D. Stop.

Back ten steps. Pivot 90-degrees on the haunches left.

Return to lineup at the jog or exit at the jog.

	Stop / Halt
	Lope
	Jog
	Walk
	Back
	Marker
	Lineup

This pattern is appropriate to use for all age groups

If used at a Regional or National Show, pattern may not be run from the lineup.

# Western Horsemanship

## LEVEL 3 • PATTERN PP

The drawn description of this pattern is only intended for the general depiction of the pattern. Exhibitors should utilize the arena to best exhibit their horses.

Be ready at marker A.

Jog. Extended jog corners. Stop.

360-degree turn to the right on the haunches, lope corners on correct leads.

Simple change of leads through walk or jog.

Lope turn, Simple change of lead through walk or jog.

Extended lope, return to lope at start of straightaway.

Transition to walk without losing forward motion. Stop and back approximately ten feet.

Return to lineup at the jog or exit arena at the jog.

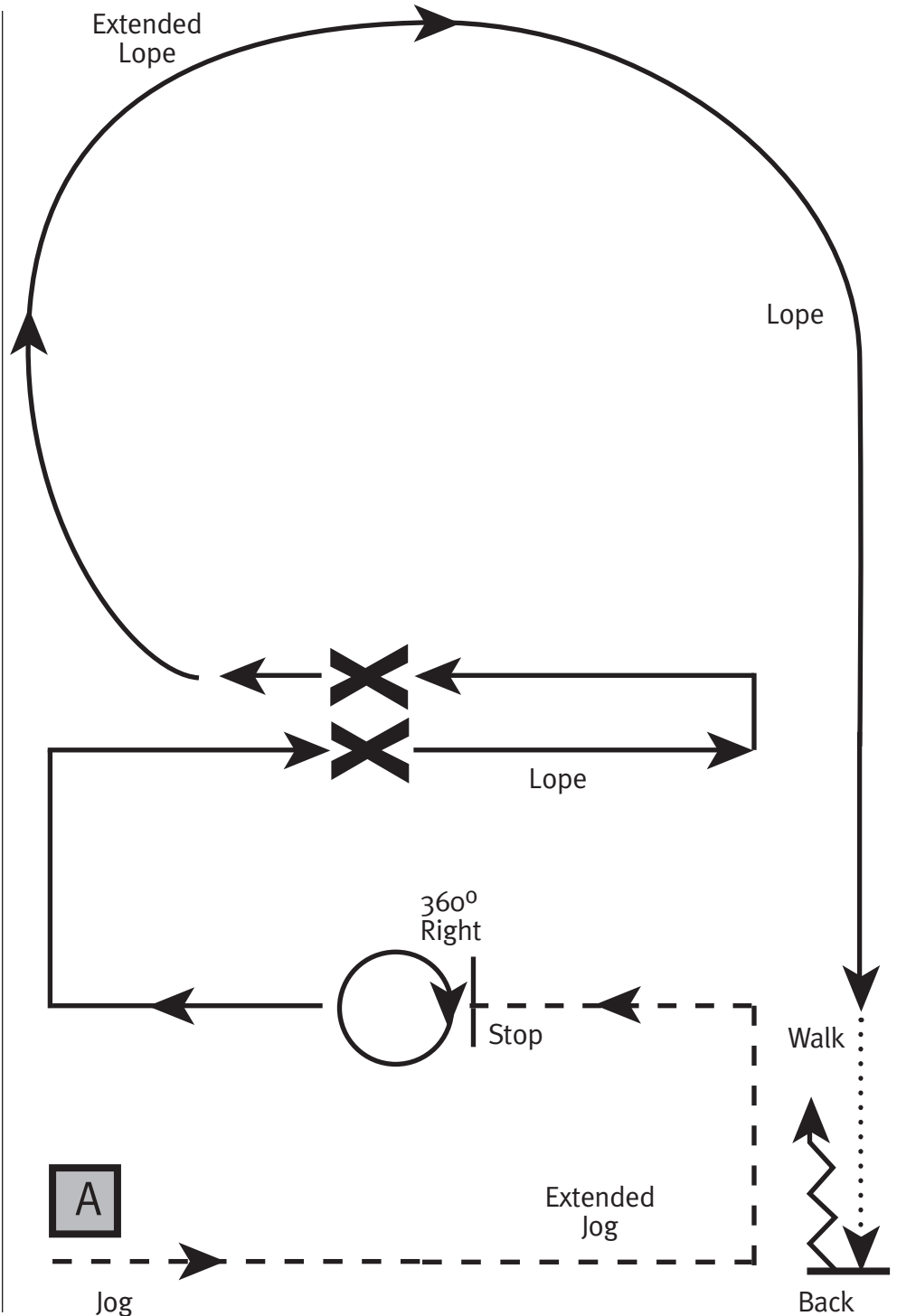
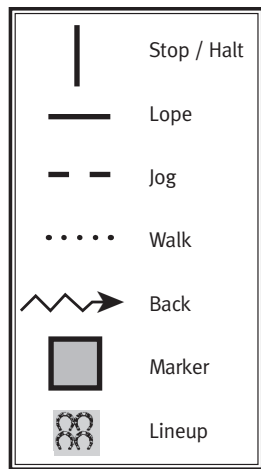

This pattern is appropriate to use for all age groups

If used at a Regional or National Show, pattern may not be run from the lineup.

# Western Horsemanship

## LEVEL 3 • PATTERN RR

The drawn description of this pattern is only intended for the general depiction of the pattern. Exhibitors should utilize the arena to best exhibit their horses.

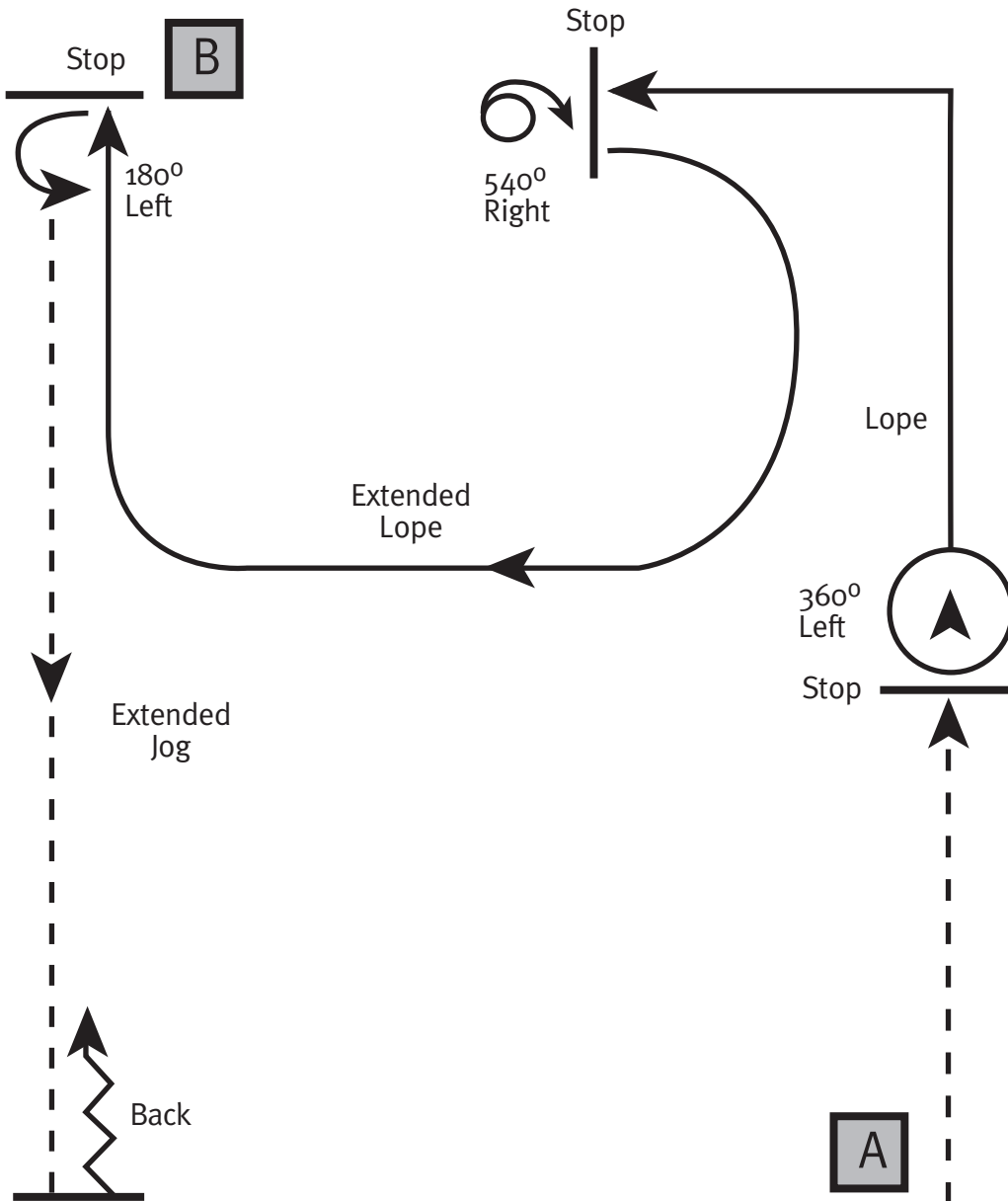

Be ready at marker A. Jog half way.  
 Stop and perform a 360-degree turn left on the haunches.  
 Lope on the left lead until even with marker B and make a square corner toward B.  
 Half way to marker B. Stop and perform a 540-degree turn right on the haunches.  
 Extended lope on right lead to marker B. Stop.  
 Perform a 180-degree turn left on the haunches. Extend the jog until even with marker A.  
 Stop and back one horse length. Return to lineup at the jog or exit arena at the jog.

	Stop / Halt
	Lope
	Jog
	Walk
	Back
	Marker
	Lineup

This pattern is appropriate to use for all age groups  
 If used at a Regional or National Show, pattern may not be run from the lineup.

# Western Horsemanship

## LEVEL 3 • PATTERN SS

The drawn description of this pattern is only intended for the general depiction of the pattern. Exhibitors should utilize the arena to best exhibit their horses.

Be ready at marker A.

Extended jog to center. Stop.

360-degree turn to the right on the haunches.

360-degree turn to the left on the haunches.

Lope a large circle on the left lead at the extended lope.

Simple change of leads (walk or jog). Lope a small circle on the right lead.

After completing circle, jog, stop and back.

90-degree turn on the haunches to the right.

Return to the lineup at the jog or exit arena at the jog.

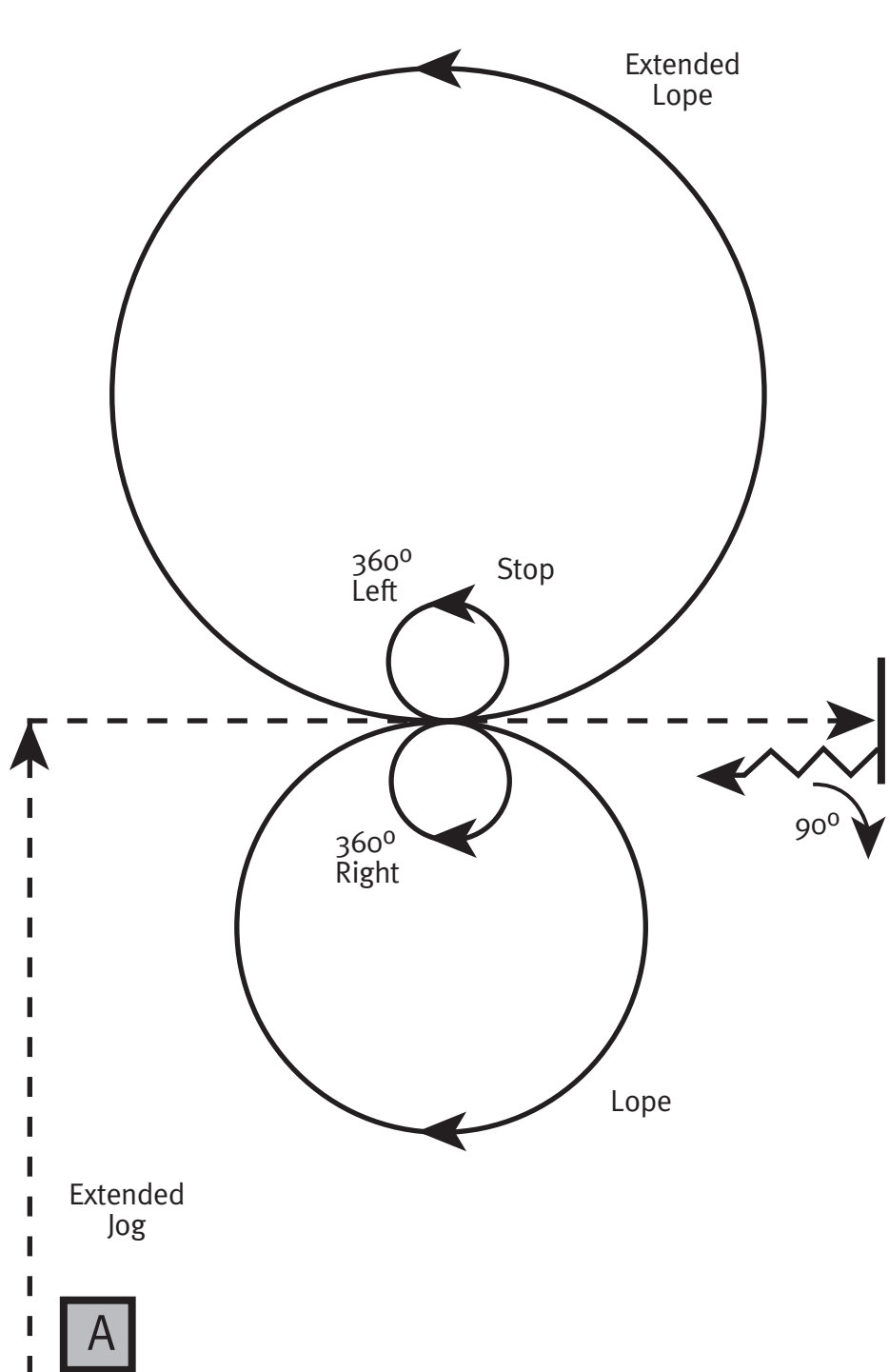
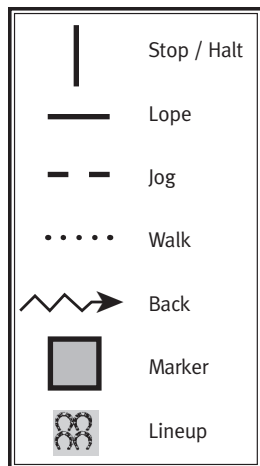

This pattern is appropriate to use for all age groups

If used at a Regional or National Show, pattern may not be run from the lineup.

# Western Horsemanship

## LEVEL 3 • PATTERN UU

*The drawn description of this pattern is only intended for the general depiction of the pattern. Exhibitors should utilize the arena to best exhibit their horses.*

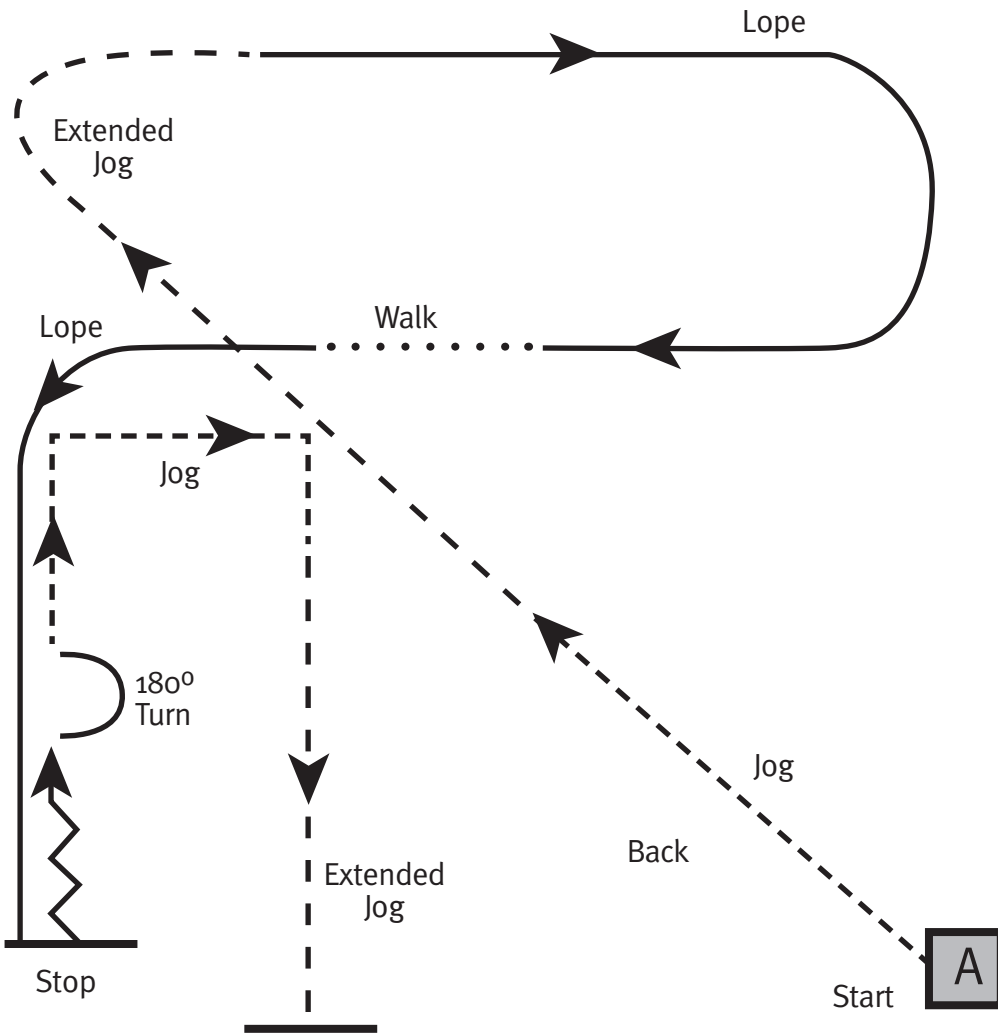

Be ready at marker A.

Jog.

Extended jog.

Lope, right lead.

Walk.

Lope, left lead.

Stop even with cone A, back at least one horse length.

Execute a 180-degree turn either direction on the haunches.

Jog 2 square corners.

Extended jog and stop.

Return to line up or exit arena as directed by ringmaster.

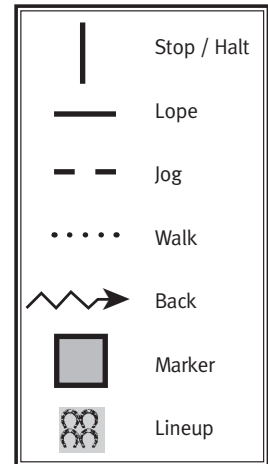

*This pattern is appropriate to use for all age groups*

*If used at a Regional or National Show, pattern may not be run from the lineup.*





# Western Horsemanship

## LEVEL 3 • PATTERN WW

*The drawn description of this pattern is only intended for the general depiction of the pattern. Exhibitors should utilize the arena to best exhibit their horses.*

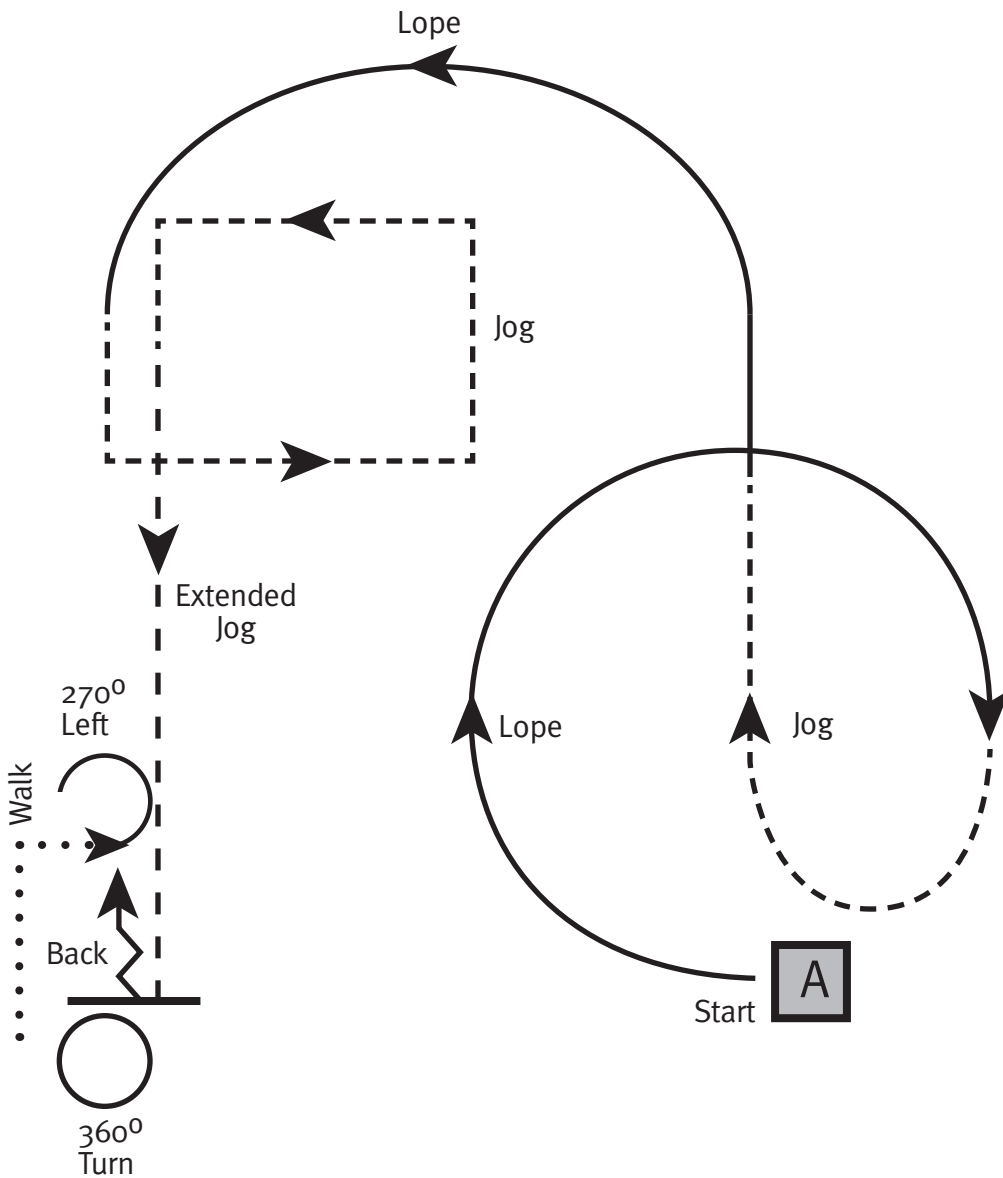

Be ready at marker A.

Lope, right lead.

Jog.

Lope, left lead.

Jog a square.

Extended jog.

Stop when even with cone A. Execute a 360-degree turn to the right.

Back at least 2 horse lengths.

Execute a 270-degree turn to the left on the haunches.

Walk, stop.

Return to line up or exit arena as directed by ringmaster.

	Stop / Halt
	Lope
	Jog
	Walk
	Back
	Marker
	Lineup

*This pattern is appropriate to use for all age groups*

*If used at a Regional or National Show, pattern may not be run from the lineup.*



# WESTERN HORSEMANSHIP

---

## Level 3

The following patterns may only be used for:

- 14 - 18
- 18 & Under
- 19 & Over

# Western Horsemanship

## LEVEL 3 • PATTERN JJ

The drawn description of this pattern is only intended for the general depiction of the pattern. Exhibitors should utilize the arena to best exhibit their horses.

Be ready at marker A.

Lope on diagonal line right lead half way to marker B and stop.

Pivot 360-degrees on hindquarters to the left.

Lope remainder of diagonal line to marker B on the left lead.

Stop at marker B and back approximately five steps.

Pivot 45-degrees on the haunches to the right, pick up right lead and lope a figure eight, crossways, at top of arena with two simple changes of lead (walk or jog). Close up figure eight and stop.

Drop stirrups and jog to marker C. Stop. Pick up stirrups.

Return to the lineup at the jog or exit the arena at the jog.

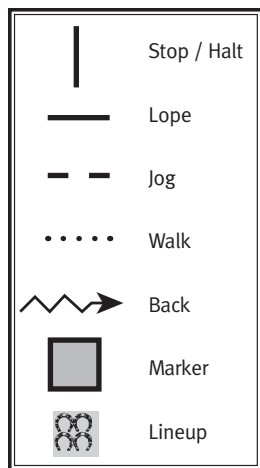

This pattern may only be used for:

- 14 - 18
- 18 & Under
- 19 & Over

This pattern may **NOT** be used for:

- 13 & Under
- 14 & Under

If used at a Regional or National Show, pattern may not be run from the lineup..

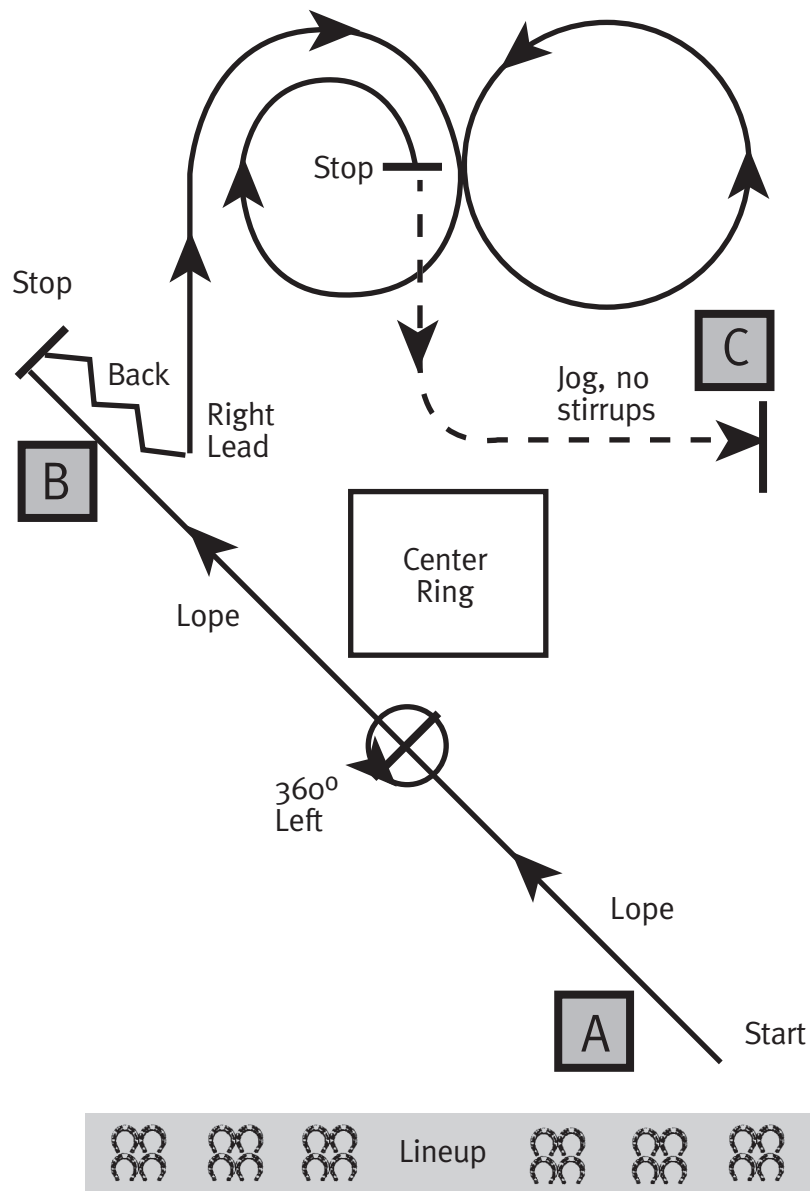

# Western Horsemanship

## LEVEL 3 • PATTERN KK

The drawn description of this pattern is only intended for the general depiction of the pattern. Exhibitors should utilize the arena to best exhibit their horses.

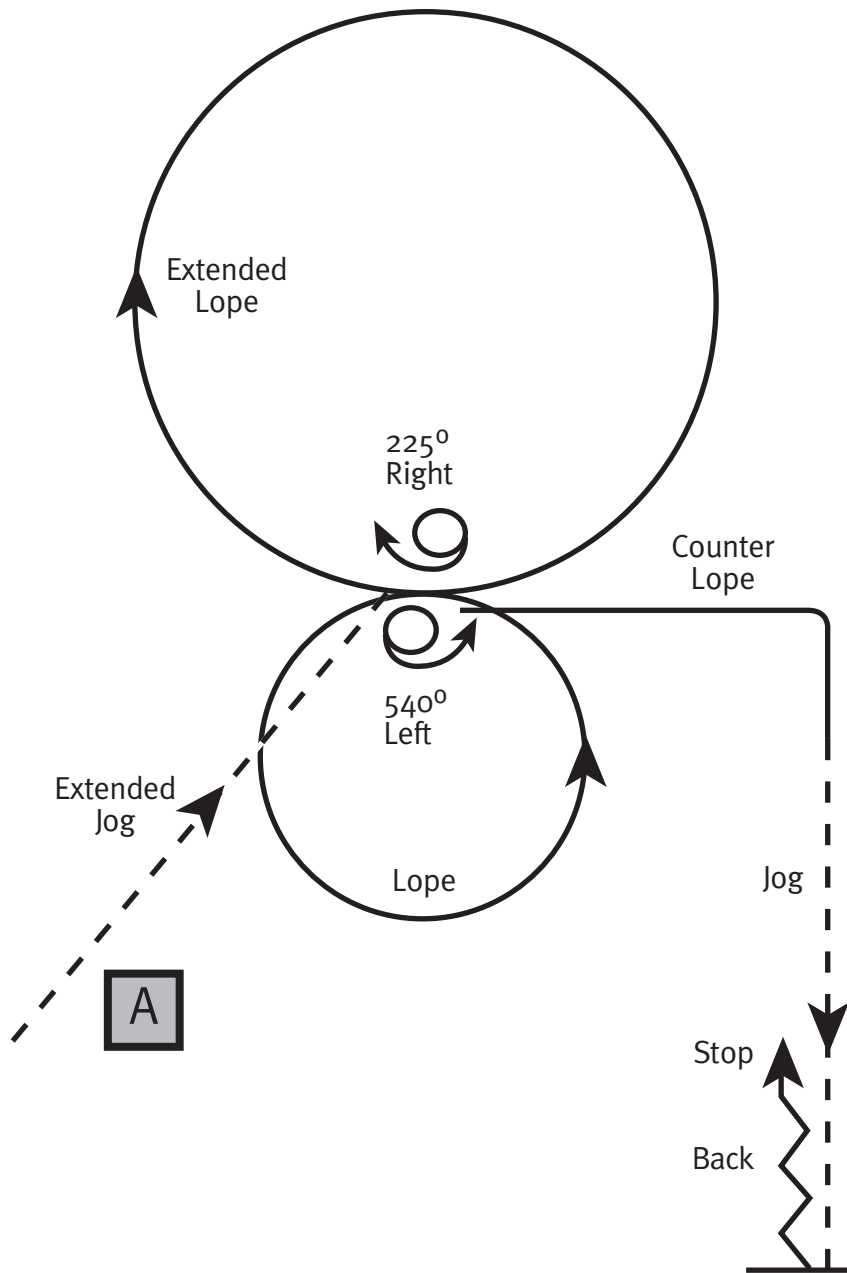

Be ready at marker A.

Extended jog to middle of arena. Stop and execute a 225-degree turn on the haunches to the right.

Lope a large circle to the right at the extended lope. Simple change of leads (walk or jog).

Lope a smaller circle to the left. Stop and execute a 540-degree turn on the haunches to the left.

Lope on the left lead and counter-lope the corner.

Jog. Stop and back ten feet.

Return to lineup at the jog or exit arena at the jog.

	Stop / Halt
	Lope
	Jog
	Walk
	Back
	Marker
	Lineup

This pattern may only be used for:

- 14 - 18
- 18 & Under
- 19 & Over

This pattern may **NOT** be used for:

- 13 & Under
- 14 & Under

If used at a Regional or National Show, pattern may not be run from the lineup.

# Western Horsemanship

## LEVEL 3 • PATTERN LL

The drawn description of this pattern is only intended for the general depiction of the pattern. Exhibitors should utilize the arena to best exhibit their horses.

Be ready at marker A. Jog from marker A to marker B.

Stop at marker B and perform a 180-degree turn on the haunches to the left.

Lope a circle to the left at the counter-lope.

At marker B perform a simple lead change (walk or jog) and perform a larger circle to the left at the extended lope on the correct lead.

Stop at marker B and perform a 360-degree turn on the haunches to the right.

Extend the jog in a circle and then continue to marker C. Stop at marker C.

Return to lineup at the jog or exit the arena at the jog.

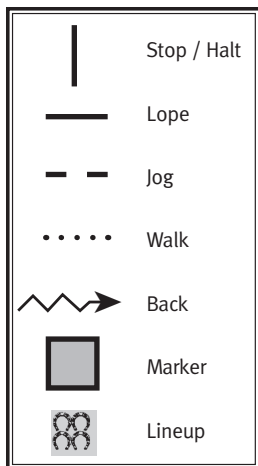

This pattern may only be used for:

- 14 - 18
- 18 & Under
- 19 & Over

This pattern may **NOT** be used for:

- 13 & Under
- 14 & Under

If used at a Regional or National Show, pattern may not be run from the lineup.

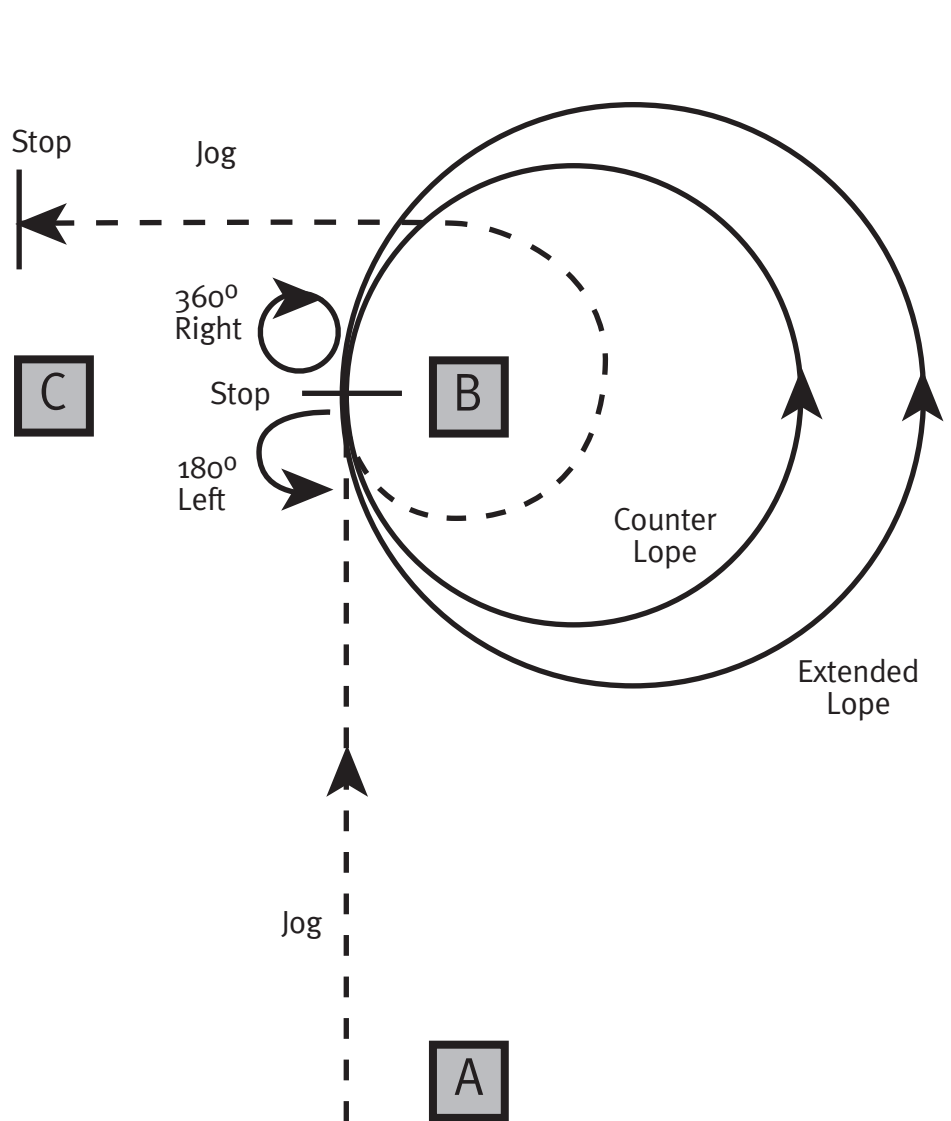

# Western Horsemanship

## LEVEL 3 • PATTERN NN

The drawn description of this pattern is only intended for the general depiction of the pattern. Exhibitors should utilize the arena to best exhibit their horses.

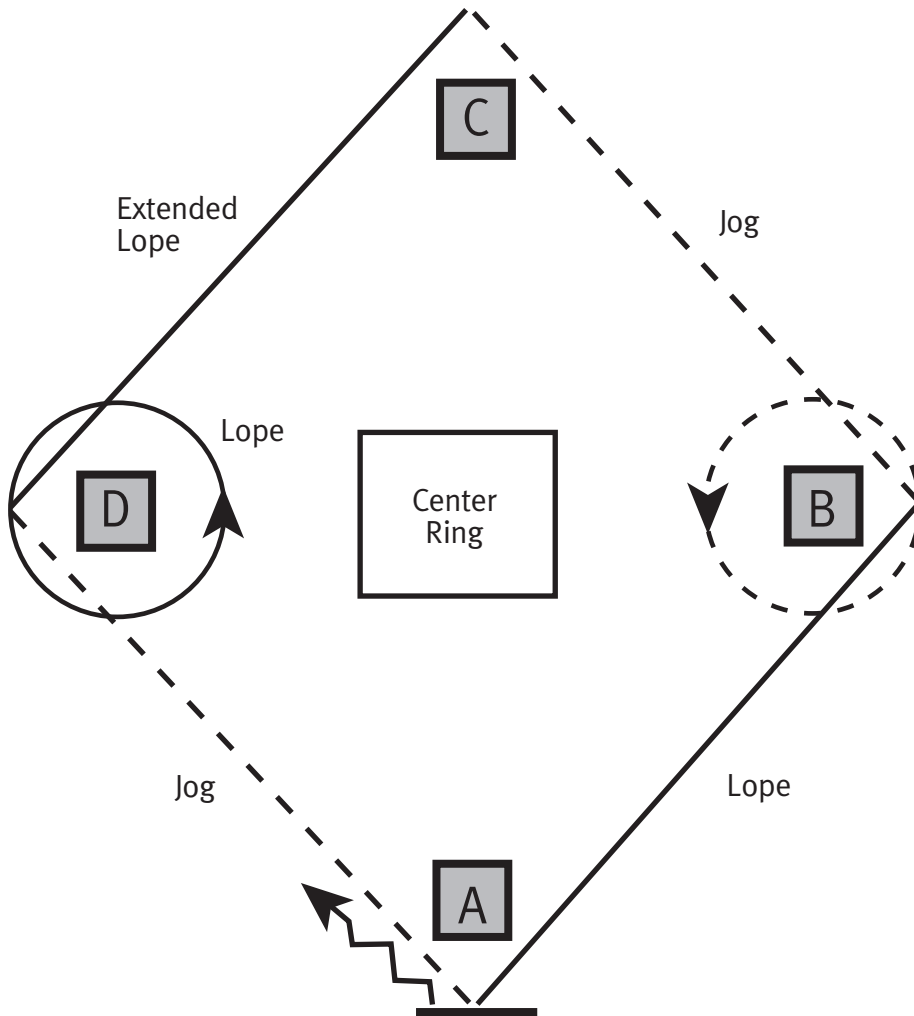

OUT GATE

IN GATE

Be ready at marker A.

Lope right lead to marker B and stop.

At marker B, drop stirrups and jog a circle to the left.

After closing circle, continue at jog to marker C and stop.

Pick up stirrups and then execute the extended lope on left lead to marker D.

Return to a lope and execute a circle to the left.

Upon completion of circle, drop down to jog and jog to marker A and stop.

Back seven steps at marker A.

Return to the lineup at the jog or exit arena at the jog.

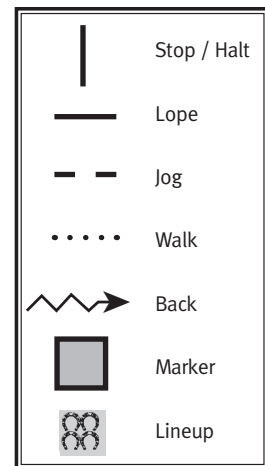

This pattern may only be used for:

- 14 - 18
- 18 & Under
- 19 & Over

This pattern may **NOT** be used for:

- 13 & Under
- 14 & Under

If used at a Regional or National Show, pattern may not be run from the lineup.

# Western Horsemanship

## LEVEL 3 • PATTERN TT

The drawn description of this pattern is only intended for the general depiction of the pattern. Exhibitors should utilize the arena to best exhibit their horses.

Be ready at marker A. Lope on left lead. Transition to extended lope 1/4 of the way down arena. At center of far end, simple change of lead (walk or jog).

Counter-lope corner, simple change of lead (walk or jog) and lope corner to middle of arena.

Transition to a jog and jog circle to the left. Extended jog a larger circle to the right, continuing across arena. Stop.

Execute a 360 degree turn on the haunches to the right and a 540 degree turn on the haunches to the left.

Lope on left lead across arena, around corner and down line. Stop and back ten feet.

Return to lineup at the jog, exit arena at the jog.

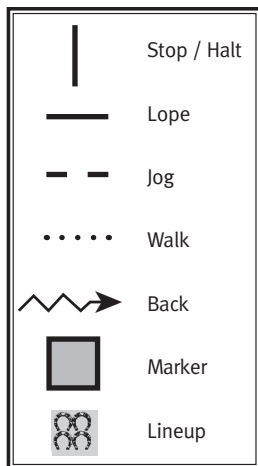

This pattern may only be used for:

- 14 - 18
- 18 & Under
- 19 & Over

This pattern may **NOT** be used for:

- 13 & Under
- 14 & Under

If used at a Regional or National Show, pattern may not be run from the lineup.

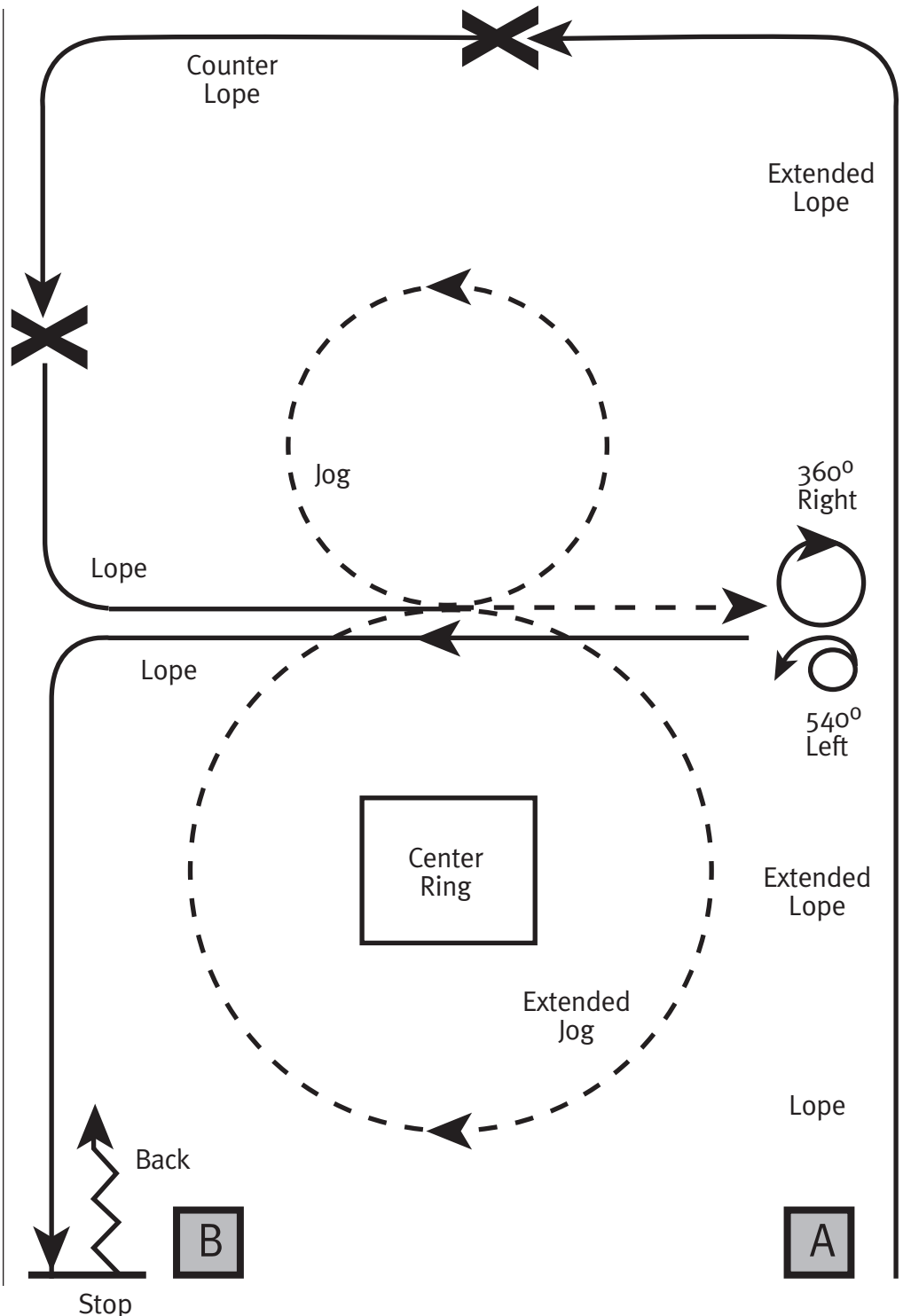



# Western Horsemanship

## LEVEL 3 • PATTERN XX

The drawn description of this pattern is only intended for the general depiction of the pattern.  
 Exhibitors should utilize the arena to best exhibit their horses.

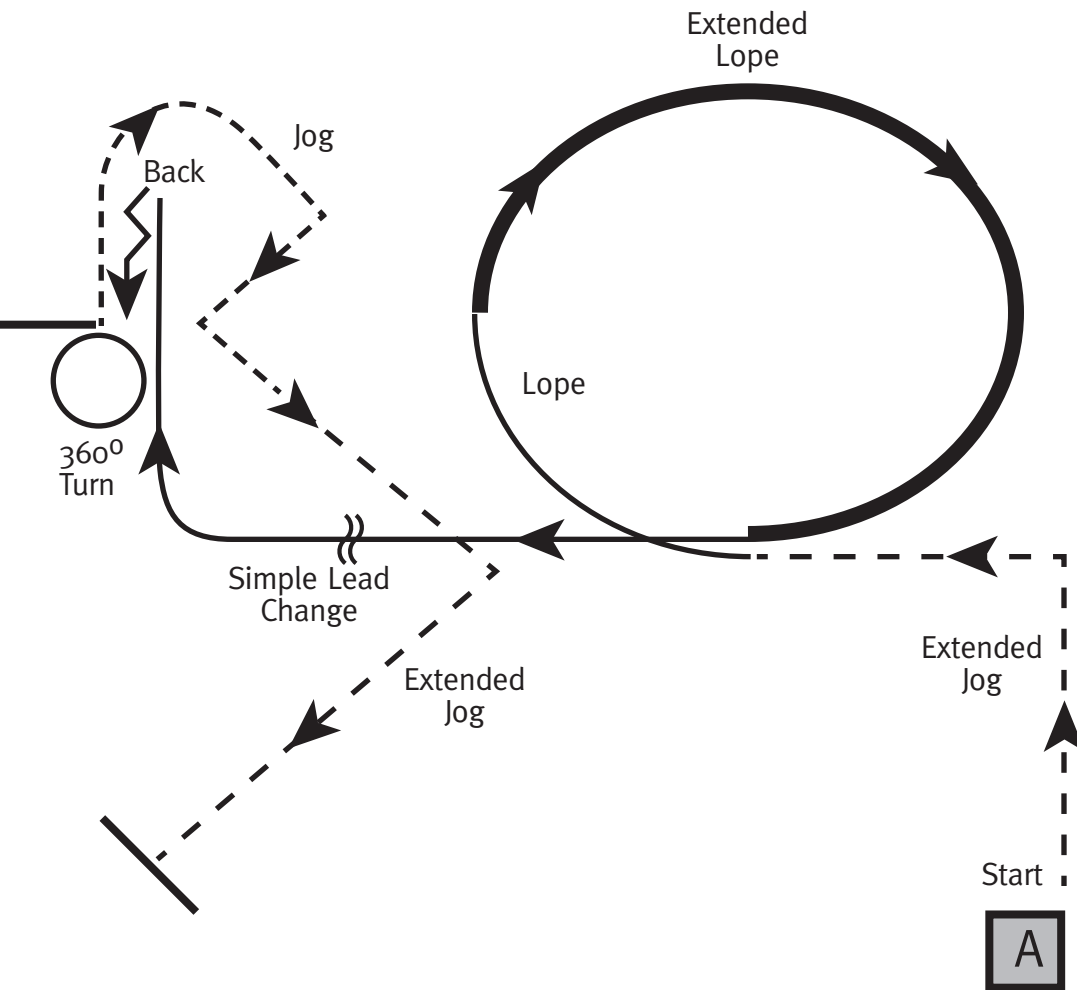

- Be ready at marker A.
- Extended jog a square corner.
- Lope, right lead.
- Extended lope.
- Collect Lope.
- Simple lead change.
- Lope left lead counter canter corner.
- Stop, back at least 1 horse length.
- Execute a 360-degree turn either direction.
- Jog 3 square corners.
- Extended jog, stop.
- Return to line up or exit arena as directed by ringmaster.

	Stop / Halt
	Lope
	Jog
	Walk
	Back
	Marker
	Lineup

This pattern may only be used for:

- 14 - 18
- 18 & Under
- 19 & Over

This pattern may **NOT** be used for:

- 13 & Under
- 14 & Under

If used at a Regional or National Show, pattern may not be run from the lineup.

# Western Horsemanship

## LEVEL 3 • PATTERN YY

The drawn description of this pattern is only intended for the general depiction of the pattern. Exhibitors should utilize the arena to best exhibit their horses.

Be ready at marker A.

Lope right lead, simple change of lead, left lead counter canter.

Extended jog.

Jog a square.

Extended jog.

Stop when even with marker A. Execute a 360-degree turn to the left on the haunches.

Back at least 1 horse length.

Execute 90-degree turn right on the haunches.

Walk, stop.

Return to line up or exit arena as directed by ringmaster.

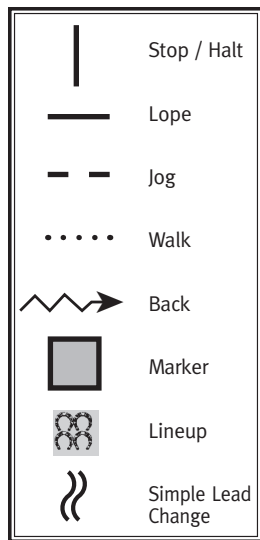

This pattern may only be used for:

- 14- 18
- 19 & Over

This pattern may **NOT** be used for:

- 13 & Under
- 14 & Under

If used at a Regional or National Show, pattern may not be run from the lineup.

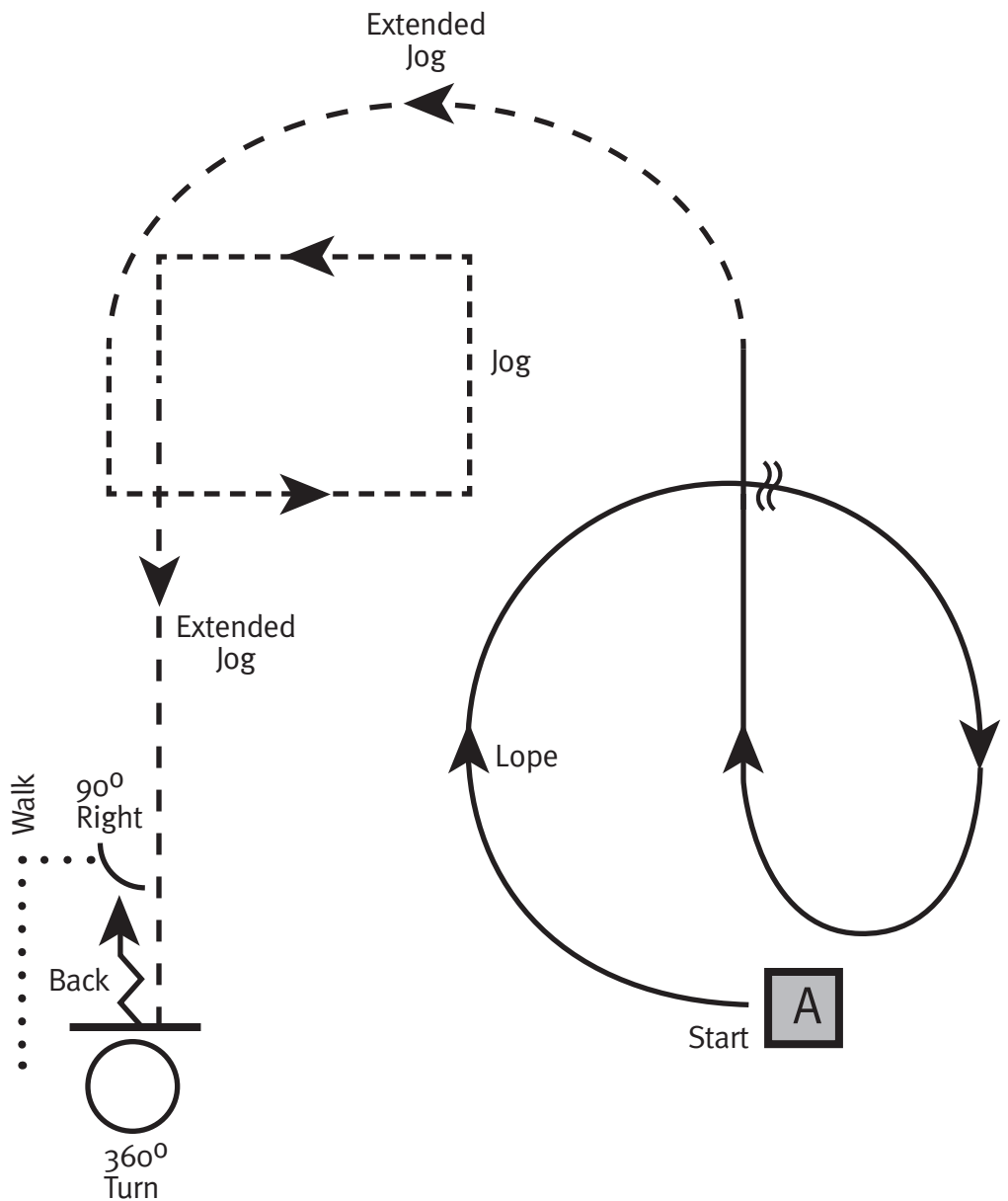

# Western Horsemanship

## LEVEL 3 • PATTERN AAA

The drawn description of this pattern is only intended for the general depiction of the pattern.  
 Exhibitors should utilize the arena to best exhibit their horses.

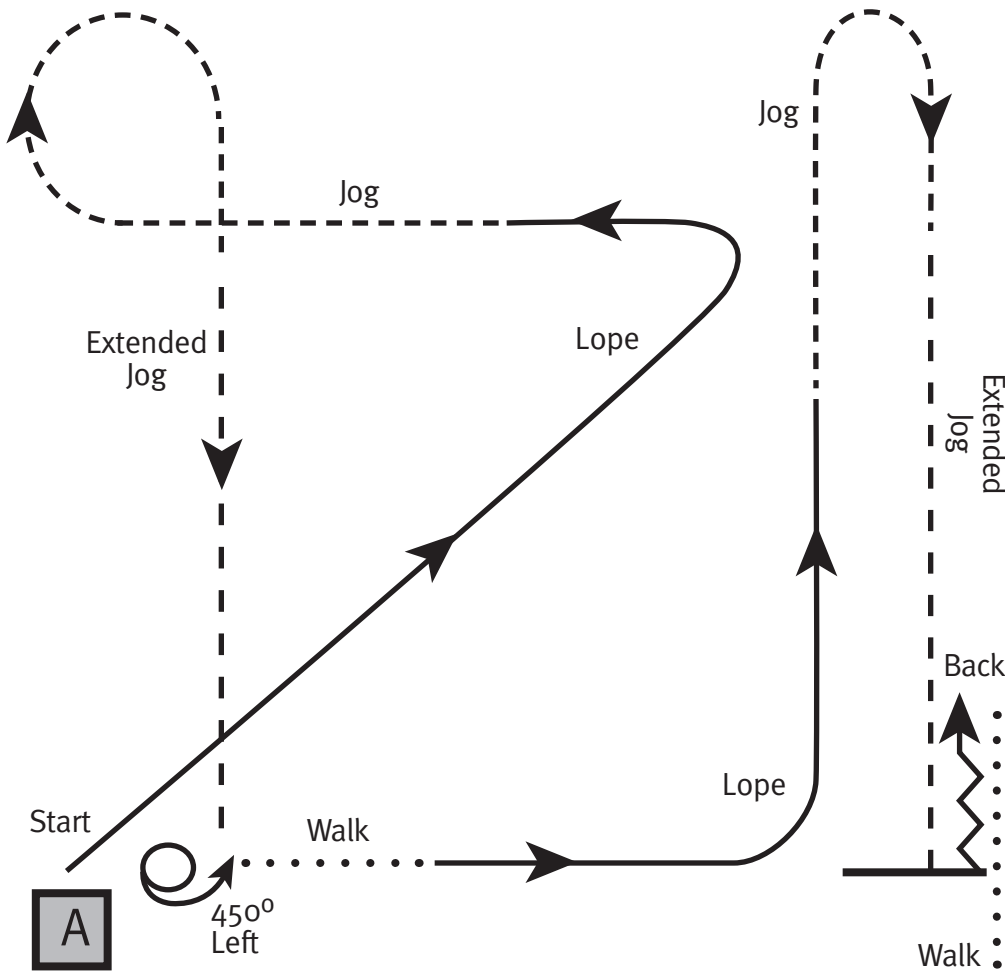

- Be ready at marker A.
- Lope, left lead.
- Jog.
- Extended jog.
- Halt, execute a 45-degree turn to the left on the haunches.
- Walk.
- Lope, right lead, counter canter.
- Jog.
- Extended jog.
- Back, stop even with cone A.
- Walk, stop.
- Return to line up or exit arena as directed by ringmaster.

	Stop / Halt
	Lope
	Jog
	Walk
	Back
	Marker
	Lineup

This pattern may only be used for:

- 14- 18
- 19 & Over

This pattern may **NOT** be used for:

- 13 & Under
- 14 & Under

If used at a Regional or National Show, pattern may not be run from the lineup.

ARABIAN HORSE ASSOCIATION  
6030 Greenwood Plaza Blvd, Suite 100 • Greenwood Village, Colorado, 80111  
(303) 696-4500 • [www.ArabianHorses.org](http://www.ArabianHorses.org)

