

WORKING HUNTER



Prepared By the
Education/Evaluation Commission
and
Judges & Stewards Commissioner
6030 Greenwood Plaza Blvd, Suite 100
Greenwood Village, CO 80111-4825
(303) 696-4539

© 2023 Arabian Horse Association

WORKING HUNTERS

Table of Contents

GENERAL.....	2
SCORING.....	3
NUMERICAL SCORES.....	3
SCORING TIPS.....	4
MOVEMENT.....	5
THE JUMP.....	6
THE ARC.....	6
STRIDES.....	6
LEADS.....	7
PACE.....	8
BENDING.....	9
JUMPING FAULTS.....	10
CREDITS.....	19
USING THE SCORECARD.....	19
JOG.....	21
APPOINTMENTS.....	21
THE COURSE.....	22
TROUBLE SHOOTING LIST.....	23
HUNTER VOCABULARY.....	23

GENERAL

THE GOOD WORKING HUNTER has free flowing, reaching strides of adequate length to travel between each fence of a line in the proper number of strides with minimal effort. The hunter should have a balanced, sweeping motion that efficiently covers a considerable distance as if it were traversing across a countryside following hounds after a fox.

The good hunter has the mechanics of a good jumper, meets each fence squarely at the correct take-off spot for a perfect arc over the fence, take-off and landing equal distance from the fence. The hunter's jumping effort will be correct and athletic with forearms held at least parallel to the ground, the joints of the front legs folded and tucked tightly up in front of its chest. The neck and back are arched slightly over the fence, hind legs tuck up and follow straight over the fence.

Maximum credit should be given to the bold, responsive, confident individual that guides

willingly with the rhythm, pace and impulsion required to safely jump the fences in correct form with strength and finesse. The hunter must be balanced in all aspects; conformation, gait and disposition.

The working hunter is a true athlete that has the scope, or jumping ability, to make the demands and challenges of jumping a course appear easy. Ultimately, the hunter is very eye appealing and gives the impression of being sure, safe and pleasurable to ride over a course of fences.

JUDGING

Ideally, the working hunter should meet every fence squarely at the correct take-off spot for a perfect semi circle arc over the fence with the take-off and the landing equal distance from the fence. Its jumping efforts will be "snappy," correct and athletic. The forearms will be held parallel, or higher, to the ground, with the joints of the front legs folded and tucked up tightly in front of the chest. The neck and back are arched over the fence with the hind legs tucked up behind, straight, not twisting to the side. The head and neck are reaching forward, ears are alert and the eyes are looking ahead.

Horses should begin the course at a good hunter pace, this pace must be suited to the size of the fences and the arena. This pace will be maintained throughout the entire course traveling between fences in the correct number of strides on the correct lead for the direction being traveled, changing when necessary. The hunter stays straight through its body when jumping fences on a straight line and bends in the direction of travel in the corners and through turns.

However, the ideal doesn't happen every time, so you must learn to identify mistakes and learn how to penalize or credit each hunter round as it happens. It's the judge's obligation to rank a class of horses by accurately

recording what took place at each fence in a course. The judge's observations are recorded through a system of symbols and at the end of each round a score is assigned between 0 and 100 based on those record observations, manners and way of going.

Every judge has a responsibility to each exhibitor to have reasons in support of the opinion rendered, and only with knowledge and good bookkeeping can an accurate score be assigned. Record each horse's fence-by-fence performance as accurately as possible, take into consideration its way of going and form an overall impression of the round and give a numerical score. Judge each round as it happens. Do not have any preconceived expectations, as the best horse giving the best performance should be the winner, and it may not be your all time favorite horse, but it is the best horse giving the best performance at that time. Give credit where credit is due, penalize where faults or mistakes occur and score the round

Usually the best location to judge a working hunter class from is outside the arena, elevated so you can see the entire course, and from an angle or side where you can see the most side views of the horses and the course.

Unlike in Reining classes, where penalties are assessed specific deductions: in Hunters, faults are scored according to the judge's opinion, and depending on the severity, may be considered minor or major. Often knockdowns are very different from each other. A horse that plows through a fence tossing lumber everywhere should be assessed a greater penalty than the horse that hits a rail, and the rail falls. If a predetermined point deduction for a knockdown was assessed it would not allow the judge to distinguish between a knockdown and a KNOCKDOWN on the score sheet and in the final numerical score.

Therefore, scoring the hunter is based on the judge's opinion as to the penalty given, and

depending on the severity of the fault may be a minor or a major fault. The more dangerous the fault, the greater the penalty.

SCORING

Scoring hunters is done by a numerical score from 0 to 100. This score must reflect the hunter's way of going, manners and movement as well as jumping technique, form and style or any faults, mistakes or errors incurred while on the course.

Judges shall penalize unsafe jumping and bad form over the fences, whether touched or untouched. Horses with major faults must be penalized accordingly. The more dangerous the fault, the greater the penalty.

When each horse enters the arena the judge should immediately observe the horse and evaluate its movement and quality as the horse picks up a pace and gallops to the first fence. At that time the judge should make an assessment as to which numerical bracket that entry best fits into and mentally determine a preliminary score. With each subsequent jump that score will be adjusted to reflect the further performance of that horse. The basis for those adjustments will be recorded and the final score will result from what took place over the entire course.

Remember: The hunter class is ultimately a placed event, not a scored event like reining, therefore, the judge's rankings are the important concern and not the exact numerical score given. The scoring system is only a tool to enable the judge to accurately rank horses. The judge must break ties by the use of good bookkeeping, comparing rounds and general impression. There are no re-works or jump-offs.

NUMERICAL SCORES

90 - 100 Excellent to perfect: This horse has everything and performs accordingly. This

horse has presence, is an excellent mover, has excellent jumping technique with scope and style, an even pace, and free-flowing stride that allows it to meet the distances easily, a good attitude, safe, quiet manners .and makes no mistakes. It performs the entire course with balance, cadence and style.

80 - 89 Good to very good: An above average horse with no faults. A good mover, a good jumper with scope and style. Horse is quiet, has a consistent pace, balanced and cadenced, makes the distance or strides between jumps easily, does everything well, but not particularly outstanding. Or an excellent horse that made slight or minor mistakes may move to this numerical range.

70 - 79 Average: A fair mover with acceptable jumping technique, style and form, keeping a consistent pace and making no major mistakes, but lacks the cadence and balance of the scopier horse. Good horses with slight or minor mistakes may move to this numerical range, even an excellent horse that really wasn't, it committed several errors or mistakes, may move-to this numerical range.

60 - 69 Poor: Poor movers, poor athletes, making only minor mistakes. A below average performance. A fair mover with less than adequate jumping technique, style or form. Average horses with one or two minor faults, no major faults.

50 - 59 One Major Fault: Horses that commit one major fault should not end up with **any** higher a numerical score, regardless of its preliminary impression These include, but are not limited to, hind knockdowns, dropping a leg, adding a stride in a combination, trotting on course, cross cantering, a dangerous fence.

40 - 49 Serious Major Fault: Horses that commit a serious major fault should not end up with any higher a numerical score, regardless of its preliminary impression. These include, but are not limited to, front

knockdowns, refusals, jumping in a manner that extremely endangers horse and/or rider.

30 - 39 Two or More Major Faults: But makes it through otherwise.

10 - 29 Jumping in an Extremely Unsafe Manner, a Dangerous Jumper, several major faults, .however it avoids elimination.

0 - Elimination: Elimination may result from **any** of the following:

- 1) A total of three disobediences accumulated anywhere on the course, including refusals, stops, run-outs, an extra circle on the course, showing a horse an obstacle
- 2) Jumping a fence before it is reset, even if dislodged by a previous competitor.
- 3) Bolting from the arena.
- 4) Off course. Missing a jump, taking a fence in the wrong direction or out of order is off course.
- 5) Fall of horse and/or rider. Horse is considered to have fallen when the shoulder and haunch on the same side touch the ground or a jump and the ground. Rider shall NOT remount in the ring.
- 6) Illegal equipment, bandages, boots on the horses legs. All artificial appliances, including but not limited to nasal strips, **nose nets, belly bands,** boots, wraps and bandages are prohibited. In the case of inclement weather competition management may permit the use of bell boots
- 7) Stopping for loss of shoe or broken equipment.
- 8) Failure to enter the ring within one minute after an audible signal is given.

UPON ELIMINATION COMPETITORS MUST IMMEDIATELY LEAVE THE ARENA, NO SCHOOLING FENCES.

SCORING TIPS

- **POOR JUMPING FORM:** may score from the 60's to the 40's

- **KNOCKDOWNS:** scores from 59 down
- **REFUSALS:** First in the 50's, second in the 30's, third is elimination
- **WRONG LEADS, SKIP CHANGE, CROSS CANTERING:** scores 60's and down, depending on frequency, length of time wrong and lack of balance caused.
- **DANGEROUS JUMP:** scores 59 and down, even when jumped clear
- **USE OF STICK:** scores 60 and down {shows unwillingness of horse}
- **BREAK OF GAIT, TROTTING:** scores 60 and down
- **ADDING A STRIDE IN AN IN AND OUT:** 59 and down

LAME HORSE ON JOG IN IS ELIMINATION: the rider probably knows that it is lame, the other competitors know it is lame, don't use it.

RULE OF THUMB, BUT NOT WRITTEN: Refusals and front knockdowns do not beat a clear round unless the clear round was so dangerous that the horse's or rider's safety is at risk.

CREDITS: Consistency in good form and style, athletic jumper showing scope and ability, presence and good attitude, sure and safe, a smooth, even round.

MOVEMENT

- **AN EXCELLENT MOVER** is a picture of elegance as it swings its legs forward with each step and stretches for ground with minimal upward and maximum forward thrust. The horse appears to be floating across the ground with suspension and grace. The hind legs reach forward maintaining solid impulsion, the hocks open and close with a fluid movement that allows the horse to reach forward with flowing, impulsive steps. The horse's head and neck are carried in a natural, relaxed expression. The overall impression is strength, quality and athleticism with balance and cadence. The excellent mover is also probably a well conformed

individual with a sloping shoulder, short back and strong hindquarters, allowing it to reach for ground easily and maintain a balanced way of going, good gallop and jumping ability.

- **A GOOD MOVER** displays a long, low stride swinging its legs forward with each step and stretches for ground. The hind legs reach well under the body, hocks bending allowing the horse to reach for ground with flowing, athletic steps. The horse's head and neck are carried in a natural, relaxed manner. The main difference between an excellent mover and a good mover is the extra flowing motion and elegance of the excellent mover.
- **A FAIR MOVER** is a horse that is a good mover in some respects, but has some locomotion flaw. Maybe a nice long stride but too high action, or long low action but too short-strided. Has movement just good enough to get by as a hunter-. Head and neck carried in a natural, relaxed manner.
- **A POOR MOVER** may be short-strided, high action, cloddy, choppy, stiff moving and lacks the look desired in a hunter. It often looks bumpy, rough, or unpleasant to ride. The horse's head may be carried too high with the back hollowed causing short strides and rough movement, or the head may be carried behind the vertical causing the horse to appear tense. A poor mover may also be a poorly conformed individual which causes its poor movement. It is also difficult for a poorly conformed horse to jump correctly.

THE JUMP

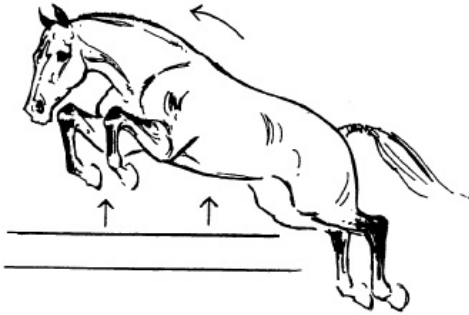

- As the horse approaches the fence its eyes and ears should look ahead, the pace remains constant to the fence. On take-off the horse should plant both hind feet, rock back onto the hocks and push off the ground with effortless strength.
- As the horse leaves the ground both knees should be pulled forward up away from the fence with a little snap and tightly tucked up in front of the chest, lifting at the shoulders and pulling the forearms at least parallel, or higher, to the ground, bending the joints of the knees and ankles folding them neatly.
- The horse should use itself by lifting and tucking up the belly, arching the neck and back slightly creating an arc or bascule over the top of the fence. The neck and head should reach forward slightly for balance and the hind legs should tuck up straight behind the horse.
- The horse's scope or jumping ability is shown through the impulsion or strength from the hindquarters, a lifting through the back and shoulders, a bend and snap with the front legs and a reach with the neck, all done straight and smoothly with ease and finesse.

THE ARC



- The horse should arrive at the take-off spot about five to six feet in front of the jump, but at least as far away from the jump as the fence is high.
- On landing the horse's front legs will straighten, the neck and head will raise a little, balancing as it hits the ground. The landing should be the same or equal distance away from the fence as was the take-off, usually about five to six feet.
- If the fence is a very low fence, less than 3 feet high, the take-off and landing should not be six feet away, but closer to the height of the fence, 4 or 5 feet, creating the same, but smaller, equal arc.

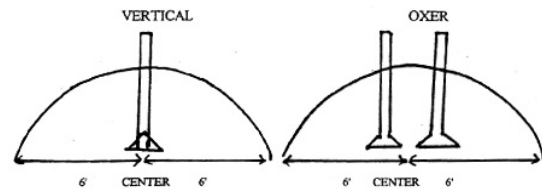

- The take-off, the flight or clearing of the fence and the landing should form an equal semi-circle arc over the fence.

STRIDES

- The average length of stride for a hunter is 12 feet. Therefore, a line (two or more fences in a row that are jumped consecutively without a change of direction) is set in 12 foot multiples.
- Course designers should allot 6 feet in front of a fence for take-off and 6 feet after a fence for landing, for a total of 12 feet. They then add another 12 feet for each stride to get the desired number of strides in a line.
- **Remember:** The distance divided by 12 - less 1 = number of strides

- For example, if the distance between two fences is 48 feet, divide by 12, you get 4. 4 less 1 equals 3. The correct number of strides in a line with a distance of 48 feet between fences is three. Three strides in 48 feet.

DISTANCE IN THE LINE BETWEEN FENCES - 48 FEET

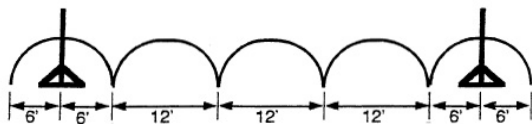

3 STRIDES

- An in and out combination is two fences which may have one or two strides between the fences. The two fences may be set 24 feet apart for one stride or 36 feet apart for two strides. Hunters be penalized for adding strides in an in and out. Hunters should have the required pace, stride and athletic ability to jump in and out of a combination in the correct number of strides.
- Every hunter should be able to get in and out of a combination of one or two strides in the correct number of strides if set properly.
- What about the small-strided horse? Should it be penalized for not making the line in the proper number of strides? In distances of 48 feet or greater, three or more strides, **not** an in and out combination, the answer is ... if a horse has good form over the fences, maintains a suitable pace for the size of the fences without being overly checked by the rider, and moves well between fences, then it may not necessarily be heavily penalized for having added a stride and may place above a horse that appears dangerously fast or out of balance to make the "correct" number of strides.
- If another horse has good form over the fences, maintains a suitable pace for the size of the fences and moves well between fences and has the correct

length of stride, pace and athletic ability not to have to add the extra stride it should be credited and place above the horse which added a stride.

- Long, low reaching strides are important criteria in a hunter, if the horse is short-strided, it may not be suited to be an ideal hunter.

NOTE: In classes where the fences are less than 3 feet, the jumping effort is smaller, therefore the distances between fences should be shortened or, if distances in the lines are not shortened, strides may be added to compensate for the small fence height and smaller jumping arc. This may occur in low hunter classes, Equitation classes and amateur or junior to ride classes. Check with your course designer, double check fence heights and distances.

LEADS

THE HUNTER MUST BE ON THE PROPER LEAD FOR THE DIRECTION IT IS TRAVELING.

- However, both landing on the correct lead off a jump or making a flying change to the correct lead when necessary is correct and should be considered equal. Being equal does mean however, that the horse changes leads easily and smoothly without being pulled, cranked, shoved or thrown sideways to change leads. The horse should change leads in a balanced, easy, natural, willing manner. After all an athletic horse wants to feel balanced and the correct leads allow it to feel balanced. Penalize the horse that doesn't change leads correctly, easily and smoothly.
- As for the horse that lands on the incorrect lead and refuses to do a flying change, it will take one of four options; remain on the wrong lead, cross canter by changing leads in front but not behind, cross canter for a few strides then change behind to the correct lead

or cross canter around the corner then change back to the wrong lead.

- The horse which cross canters a few strides then changes completely is penalized less than the horse that does not change at all. A late lead change is better than no lead change. The wrong lead is however, better than a cross canter. Although the horse on the wrong lead is not balanced on the corners, the horse in a cross canter is disjointed and out of balance, making it rough or difficult for the rider to properly place the horse for take-off and sometimes causes unbalanced, one-legged take-offs. Considering balance at take-off, it would be better for the horse to switch back to the wrong lead before the jump than to attempt to jump the fence unbalanced out of a cross canter.
- The horse that constantly switches leads between fences on a straight line or on the approach to a fence should be penalized as it is out of balance, may hinder the rider's ability to judge the distance to a fence, and interrupts the rhythm.
- Breaking gait or trotting to change leads rather than performing a flying change is worse than a cross canter or counter canter. Trotting shows the horse's unwillingness to go forward from the rider's leg, lack of balance and obedience. Any horse that is balanced will usually change leads when moving forward with rhythm and pace.

LEAD EXAMPLES

1st place - Correct leads

2nd place - Counter canter for a few strides then a late lead change

3rd place - Counter canter throughout corner

4th place - Cross canter, switching back to counter canter before take-off

5th place - Cross canter entire corner, attempting take-off out of cross canter

6th place - Break of gait, trotting on course

PACE

- A hunter should keep a pace that enables it to have the correct number of strides between fences and through the in and out combinations.
- The horse should meet the take-off, leave the ground on stride and in rhythm, jump, land and maintain the same rhythm to the next fence.
- The pace or rhythm developed at the beginning of the course should be maintained throughout the course without the horse dying out or getting "on the muscle", gathering speed or momentum with each stride. The horse should appear to carry or maintain the pace without rider interference, remaining quiet, calm and responsive.
- The hunter should be allowed to carry itself in a natural frame, not necessarily a hunter pleasure frame.
- The frame of the working hunter should show natural balance with the head and neck carried freely enough to balance and see what's ahead to measure height and distance. If the head is behind the vertical or if it is carried too high the horse cannot see what is in front of it until too late.
- The horse should not be overly collected nor should it be strung out not accepting the bit, it must be on the bit accepting guidance from the rider with the back relaxed, the hocks stepping well under the body with each stride carrying itself in an easy manner with strength and athleticism.
- The hunter's pace must enable it to have the correct number of strides between fences and in combinations, leave the ground on stride and in rhythm.
- The pace must remain constant and smooth with the horse relaxed, confident and balanced, on the bit with light contact allowing the rider to adjust the pace or placement for a good take-off.

- A hunter has to be able to use its neck and head freely to balance and see the fences coming in front of it.
- Since much more time is spent going between fences than actually jumping over them, the way a horse travels between fences is very important. The horse must be straight on lines, and bent in the direction of travel on bending lines, turns or corners.
- Horses should not display behavioral problems, such as bolting, rearing, bucking, kicking, pinning ears or wringing tails.

PACE AND IMPULSION

- **Basically pace is speed and impulsion is the thrust.**
- There is no real set speed at which every hunter should travel. Speed is not to be combined with number of strides. The pace depends on many factors such as, the size of the fences, the size of the arena, the horse's length of stride, ease of movement and relaxation and the way the course is set. The best rule for pace is: "use common sense."
- Does the horse look too fast? Too slow? Does the round appear dangerous due to excessive speed? Or too dull due to lack of pace? Does the horse or rider constantly have to readjust the speed to reach the correct take-off spot?
- If you answer "yes" to any of those questions, the pace is wrong for the course.
- A hunter should maintain not only a steady pace, but should maintain rhythm, moving freely, taking long, flowing strides, stretching through for proper length of stride. As the horse comes to a fence, it should maintain its pace and take off from the ground on stride with the same rhythm that it approached the fence, land and continue in the same pace or rhythm throughout the course.

- Impulsion is more difficult. Although impulsion is not marked separately on the judge's card it comes into effect when considering way of going and is evident in the horse's jumping form, which will suffer from lack of impulsion.
- The horse must use its hocks each stride for balance and to get the hindquarters underneath the body. The horse must rock back onto the hocks when it jumps to push itself off the ground rather than try and pull itself over the fence. If the horse doesn't have impulsive, athletic strides and good solid thrust off the ground at each fence, it doesn't have enough impulsion.

BENDING

- The horse should bend correctly in the direction it is traveling.
- A horse's balance, vision and length of stride are adversely affected when the horse is not properly bending in the direction of travel. Besides being wrong, there are safety reasons for penalizing the unbent or counter-bent horse.
- If a horse's head is cranked to the outside around corners it carries most of its weight on its inside legs, traveling off balance and drifts toward the center of the turn, also evading the rider's aids. A horse with its head cranked to the outside often cannot see or focus on what is ahead of it and may not see a fence until too late. The horse will lose rhythm and shorten its stride by leaning toward the inside of the curve with its head pulled to the outside.

JUMPING FAULTS

SOME COMMONLY USED SYMBOLS WHICH MAY BE USED ON THE SCORECARD

(REMEMBER EACH JUDGE MUST DEVELOP THEIR OWN SYMBOLS OR SHORTHAND, THESE ARE ONLY A FEW COMMONLY USED BY JUDGES)

TOUCHES: Light touches or rubs with the hind feet are usually not considered unless due to bad jumping or where competition is very deep and elimination is difficult. Touches or rubs with the front feet have a greater penalty because the horse should have the strength and athleticism to get its feet up off the ground without hitting the fence. Hard rubs with the hind feet also carry a greater penalty, however both are minor unless due to bad jumping or poor take-off.

Symbols for hind rub or touch

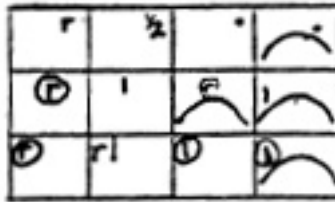

Symbols for hard rub

Symbols for front rub or touch

FRONT KNOCKDOWNS: Front knockdowns are serious major faults. Knockdowns with the front feet are usually penalized twice as much as a hind knockdown as they are usually twice as dangerous. Catching the front legs on a fence presents a much greater chance of accident or fall than does a horse hitting its hind legs, since the horse could flip over if its front end became hung in the fence. At best, a front knockdown causes the horse to lose its balance.

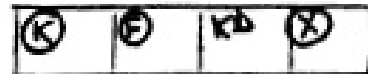

HIND KNOCKDOWNS: Carry a lesser penalty, however is a major fault. The horse should not misjudge the jump as to knock it down, nor should the horse be so lazy as to not care if it knocks the jump down.

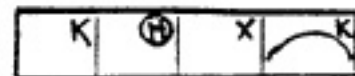

THE SEVERITY OF THE PENALTY FOR A KNOCKDOWN DEPENDS ON THE SEVERITY OF THE KNOCKDOWN

- A horse just barely rolling a rail, yet remains in good form and lands safely must still be penalized for its involvement of its feet with the rails. However, a horse that flails off the ground and crashes through the jump must be much more severely penalized.
- Use logic when assessing penalties, the more dangerous the error the greater the penalty.

REFUSALS: A serious major fault. A refusal demonstrates the horse's unwillingness to go forward, a willful disobedience.

- A refusal is usually penalized more heavily than a knockdown--an honest horse will at least attempt to jump the fence, although it may knock it down in doing so, while a dishonest horse will refuse to even try and jump the fence. Most horsemen appreciate a horse with heart, one

that will at least try, and most horsemen hate a "stopper," the horse that won't try, looks for a way out. There is also more inherent danger to a rider on an unwilling, dishonest horse than to a rider on a willing horse that just didn't put out enough jumping effort.

- A refusal occurs when a horse stops in front of a fence. If a horse stops then leaps over the fence without taking a step backward first, it's not considered a refusal. Just a very bad, close jump.
- If after a refusal the rider moves the horse forward showing the fence to the horse it constitutes another refusal. Presenting the jump to the horse.
- Bolting past a fence or running out past a fence is considered a refusal, as is an extra circle on course.
- The rider is allowed only one circle prior to beginning the course and one circle on completion of the course.
- Three refusals accumulated anywhere on course is elimination.

Symbols:

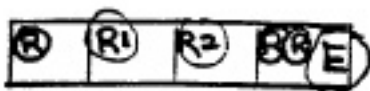

MAJOR FORM FAULTS

BAD JUMPING MUST BE PENALIZED WHETHER THE JUMP WAS TOUCHED OR UNTOUCHED

DROPPING A LEG: A major fault. The horse drops one leg down out of the air or does not lift one leg up out of the way of the fence, jumping spread legged in front, causing a dangerous situation, as the horse will often catch a leg on the fence. Usually due to a bad take-off, being out of stride or miscalculation of the jump. Severely penalized.

Symbols:

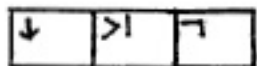

HANGING LEGS: Must be penalized severely for safety reasons. A horse that hangs its front legs could catch one or both front legs on the top of the fence and have a serious accident. You must penalize a horse that hangs its front legs even if it doesn't touch the fence.

Symbols:

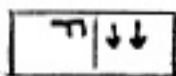

The horse drops or hangs one or both of its front legs down from the shoulder, only partially bending the knee, allowing the legs to drop back toward the belly rather than pulling the knees forward and tucking them up out of the way of the jump. The horse's legs should be brought forward and neatly tucked up while jumping so there is no danger of them getting entangled in the fence.

Hanging legs often accompanies a horse that dwells in the air, as the horse usually arrives at the jump a little too close, loses impulsion, has to jump extra hard off the ground into the air because it doesn't tuck its legs up properly, resulting in a dwell or stalling in the air.

HANGING KNEES: The horse lifts its shoulders properly but does not lie, bend and tuck up its knees. The knees hang partially unfolded, not folded tight enough to be correct. Less serious than hanging legs, still poor jumping style.

Symbols:

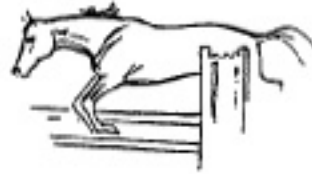
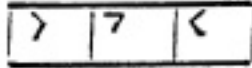

LONG FENCES: Happens when the horse leaves the ground too far away from the fence.

REASONABLY LONG: An athletic horse leaving from a reasonably long spot, makes its arc higher, appropriate to the take-off spot and land as far from the fence as it took off. Probably an acceptable jumping effort. However, a less athletic horse will probably hit the fence or knock it down, penalize this horse.

Symbols:

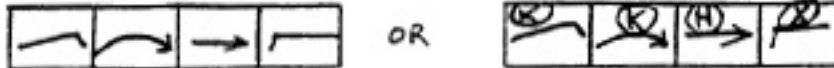

RISKY OR CHANCY JUMP: The worst long fence is a risky or chancy fence. When the horse leaves the ground too far ahead of a jump, it may have second thoughts and try to quickly put its feet back down on the ground, crashing through it, or in an all out effort, unfold the front legs and try and flail itself to the other side. Severely penalized, even if it makes it.

Symbols:

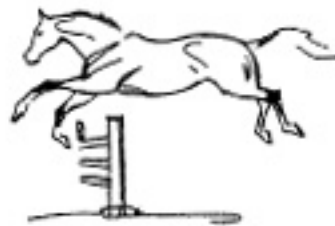
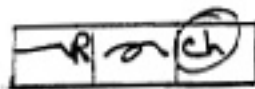

DIVING: Is another fault resulting from a long fence. The horse stretches its legs so far forward in an effort to clear the jump that it appears to be diving towards the ground. Diving presents inherent danger of the horse catching its legs on the fence. This is a serious fault.

Symbols:

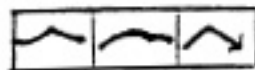

REACHING: is a less severe form of diving. The horse leaves the ground somewhat too far away and unfolds its legs a little and stretches them beyond the normal position and reaches for the ground. Still predestines a horse to catch a leg on the fence.

Symbols:

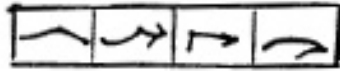

CUTTING DOWN: The horse unfolds its legs early on the landing side of the fence, landing closer to the jump on the landing side than the take-off was on the take-off side. This creates an uneven arc over the fence and the horse risks catching its rear legs on the fence as it hasn't left an appropriate distance between the fence and the landing.

Symbols:

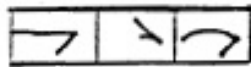

SHORT OR CLOSE SPOTS: When the horse leaves the ground too close to the fence.

CLOSE SPOT or DEEP SPOT: An athletic hunter should compensate for a close or deep spot and jump in fairly good form by collecting itself, bringing its hocks well under and rock back slightly so that its front legs will be away from the fence. A talented athletic horse will get its rider out of trouble this way. Probably an acceptable jumping effort.

Symbols:

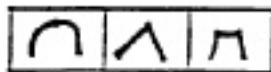

A less talented or lazy horse will hit the top of the fence with its front legs when it gets too deep or close to a fence at take-off. It will get too far under the fence and catch the fence as it brings its front legs up to jump off the ground or it may pop up off the ground making a very short awkward jump, popping over the fence. Penalize this horse.

Symbols with a front knockdown:



CHIPPING IN: Occurs when a horse arrives at the fence with its strides off or too fast and quickly throws in a very short, abrupt stride or half stride at the take off making a very awkward, short jump, often leaving the ground off of one hind leg instead of both due to the half stride. This is a serious fault as it is affected by poor pace, lack of rhythm in strides and causes both the horse and rider to lose balance.

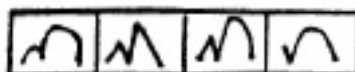

Symbols:

PROPPING: The horse seems to straighten its front legs out and push itself back away from the fence, backing off, with its hind legs under itself and the front legs extended and bracing. Often occurring when a horse approaches the fence too fast, is off stride, is not confident or is unwilling to jump.

Symbols:

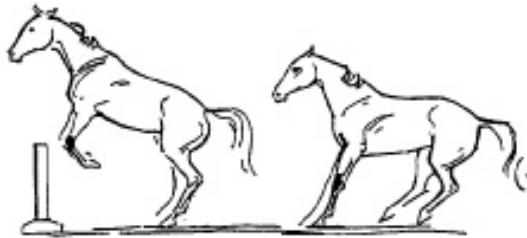
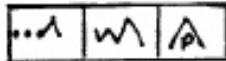

In its slightest form, propping may just be the horse shortening a stride, setting itself up for a good jump.

In its slightest form propping is not heavily penalized as a horse may prop to back itself away from a fence when it reaches a take-off spot that is unreasonably long in an attempt to make a safe jump. However, a horse that consistently props must be heavily penalized as it shows unwillingness to go forward.

Symbols:

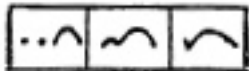

LYING ON ITS SIDE: Is a serious form fault which can be dangerous. The horse tilts or lays over so that one of its sides faces the ground and the other faces the sky. This way of jumping is unbalanced and could cause a fall. A horse that is lazy or not capable of jumping the height of the fences properly may lay on its side to compensate for lack of ability.

Symbols:

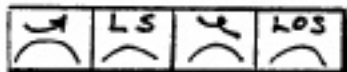

TWISTING: Is less serious, but is a major form fault. The horse's body remains straight and upright, but, its legs, front or rear, twist to the side during flight in order to clear the fence. The horse may be incapable of jumping straight or may be lazy and twist its legs out of the way rather than rocking back on its hocks and push to clear the fence or it may just be struggling to clear the fence.

Symbols:

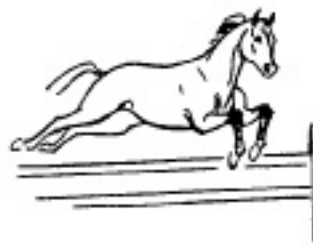
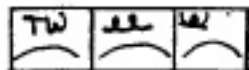

MINOR FORM FAULTS

LESS SERIOUS FAULTS THAT WILL AFFECT YOUR PLACINGS

LOOSE FORM: A horse with legs not folded tightly when jumping. Not hanging down from the shoulders, the forearms are lifted, but just not folded tightly at the knees and ankles. The horse appears to be a lazy jumper and just not giving it its best effort. In a class of athletic hunters a horse with loose form will place lower.

Symbols:

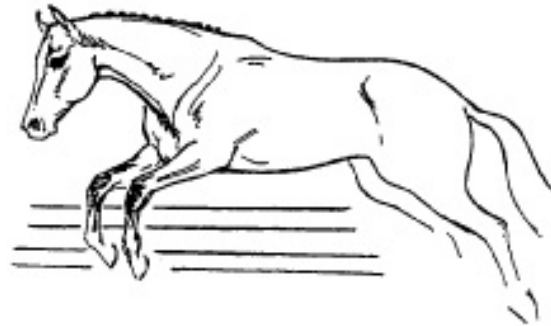
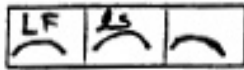

UNEVEN FOLD: A horse that does not fold its legs evenly, lets one leg fold loosely while the other may fold tightly. The horse may be sore, lazy and not giving it its best jumping effort or may just jump unevenly. Will place below horses with correct jumping form and style.

Symbols:

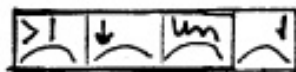

JUMPING FLAT: Horses that jump correctly with their legs tucked up but appear to have a flat back, no arc. This horse lacks scope and athleticism to elevate its body in the air and jump with proper bascule. The horse resembles an arrow with a tail.

Symbols:

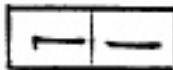

JUMPING HOLLOW: The horse's back has an inverted arc when jumping. The horse is unable to lift its back properly, this horse lacks strength and athleticism and should be penalized accordingly.

Symbols:

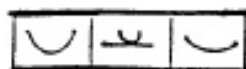

OTHER FAULTS

JUMPING OFF ONE LEG or QUESTIONABLE TAKE-OFF: When the horse does not plant both hind feet together and push itself off the ground with both hind legs. The horse or rider may have misjudged the take-off. This usually happens when the horse arrives at the take-off spot out of stride, makes an abrupt, unbalanced take-off, and sometimes a dangerous take-off. It must be penalized according to the severity or danger involved. A scramble at take-off with a flailing leap is worse than a missed step at take-off.

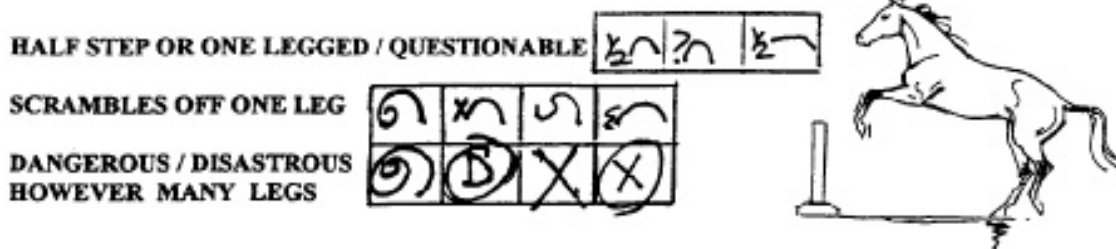

DRIFTING OR JUMPING TO THE CORNER: The horse may take-off in the center of the jump but then drifts either right or left while in the air, landing to the right or left side of the fence. Drifting is penalized because it is an evasion of the rider’s aids, a deviation in the planned line, a crooked jump and can result in injury to the rider if the horse drifts far enough to hit a wing or standard or lose balance.

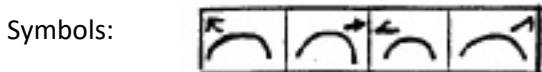

NOTE: If a horse is by the rider asked to jump the fence on an angle to make the course ride more smoothly it is not penalized. That is not considered drifting as it was planned by the rider and, if executed well, could be credited showing the horse's confidence and willingness.

JUMPING OFF CENTER or NOT IN THE MIDDLE: The horse does not jump over the center of the fence when jumping in a straight line. The horse approaches, jumps and lands to the left or the right side of the fence. Not as severe a penalty as drifting because at least the horse is jumping straight, just not in the center of the jump. However, this can still cause injury if the horse jumps too close to the wing or standard and should be penalized according to the severity of the deviation.

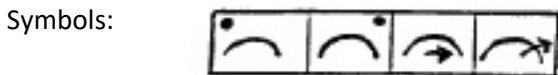

WEAVING: When the horse zig-zags on the approach to a fence, or in lines, sometimes trying to run-out past the fence or just unwilling to go straight to the fence. Penalize accordingly.

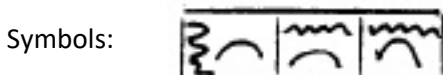

PACE FAULTS

RUSHING OR CHARGING: Horse that gets anxious and gathers speed on the approach to the fence. This horse shows disobedience to the rider, and uneven pace. The horse has to be checked back by the rider, then gathers speed again on the approach to the fence. The desired smooth, even pace of a hunter is often affected by the horse's temperament. Rushing or charging must be penalized depending on the severity.

Symbols:



OVER CHECKING BY RIDER: The rider constantly checks the horse back to try and maintain the pace or to slow the horse down after a jump to resume the pace. The horse is "on the muscle", constantly in a hurry and the rider has to readjust the pace or speed by checking the horse back, usually quite forcefully.

Symbols:

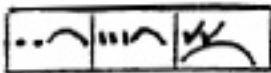

The more checks the worse the problem:

Contact with the bit and the horse's mouth to balance or adjust the horse is necessary and acceptable, constant checking or over checking of an anxious horse or a horse moving too fast is penalized.

QUICK OFF THE GROUND: Characterized by the horse's front feet quickly patting the ground on the take-off stride rather than maintaining the same rhythm. A horse that gets quick is usually high strung and makes other errors related to temperament.

Symbols:

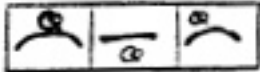

OVER JUMPING / TOO FAR AN ARC: Is associated with an anxious horse attempting to gain momentum in the air. The horse jumps hard off the ground, usually landing farther away from the jump than was the take-off spot, causing an uneven arc and it usually takes a stride or two to regain control or pace

Symbols:

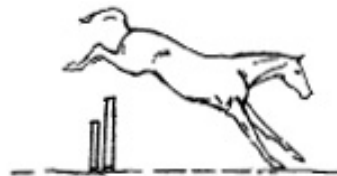
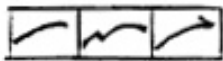

DWELLING OFF THE GROUND: Lack of momentum as the horse leaves the ground, a sense of stalling at the moment of take-off hindering its jumping ability. May be due to being unwilling, sluggish, green, afraid or lacking an easy, free-flowing stride on the approach, poor jumping style. Penalize accordingly.

Symbols:

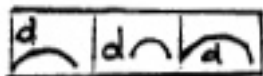



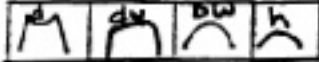

DWELLING IN THE AIR: A moment of suspension or hanging in the air often due to a poor take-off, close fence, a dull lazy horse, poor jumping style or hanging legs. Should be penalized.

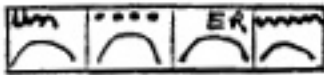
Symbols: 

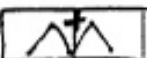

UNEVEN PACE OR PERFORMANCE: The pace is erratic, the horse slows down then speeds up, goes too fast then slows down, jumps that don't match, some long, some short, erratic jumping form.

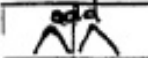

Symbols: 



MORE SYMBOLS OR DEVELOP YOUR OWN



ADDED STRIDES IN AN IN AND OUT    



ADDED STRIDES IN A LINE 



TROTting ON COURSE WHEN NOT SPECIFIED   



CROSS CANTERING   

LATE LEAD CHANGE   



ROUGH LEAD CHANGE   



COUNTER CANTER or WRONG LEAD   

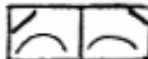

LEFT OUT A STRIDE IN A LINE  



COUNTER BEND  



CUTTING THE CORNER 



UNEVEN PACE  



STRONG  





OVER-FLEXED  

KICKING  

TENSE  

HIGH-HEADED  

BUCKING  

BAD MANNERS, SOUR, PINNING EARS, WRINGING TAIL    

RIDER USED STICK OR CROP 

TIED DOWN  **Martingales are permitted, but the horse should not abuse it**

POOR HORSE OR RIDER PRESENTATION

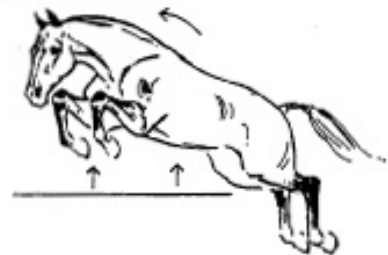

CREDITS

- Take-off on stride, making proper arc, maintaining rhythm on landing
- Smooth even pace or round, automated, cadenced even rhythm
- Smooth, even, consistent, safe and correct jumping style
- Athletic jumper, showing scope and ability, using itself well
- Good mover, smooth with adequate stride to maintain even pace easily
- Good attitude, obedient and responsive to rider

CREDIT THE GOOD HORSE AND THE GOOD PERFORMANCE

- Give credit where credit is due. Credit the horse that is a good mover, is an athlete with great jumping ability, the horse that has a good attitude, the horse that is safe and performs a smooth, correct round.

USING THE SCORECARD

- The hunter scorecard should include a section with numbered boxes for the fences on course, a box for comments, overall performance or impression, movement and a box for the numerical score.
- In judging working hunters keep as accurate a record as possible of everything each horse does during the entire round. You must devise your own symbols, shorthand or language which allows you to totally recall a round. At first, you may see only the more obvious errors, faults or mistakes, but the more you practice the more you will see and the easier it will get.

- Before the class begins, identify and label each box by the type of fence on your scorecard. Brush, flowers, white gate, in and out, brick wall, etc. It also helps to markdown the correct number of strides in the lines or in and out and which fences make the in and out, since they should be numbered separately. This will help you when referring back to the scorecard and to keep track of the jumps while scoring the round.
- You will find that the better the round the fewer the symbols you'll need or use.
- Circle major faults for emphasis and easy recall.
- In addition to marking each fence with a symbol or combination of symbols, rate each horse's movement or way of going and mark it down. This is reflected in your numerical score.
- Note jumping style, jumping ability, scope or lack of scope and mark it down.
- Also note overall impressions of and manners of the horse, such as tense, strong, high-headed, opening mouth, fighting rider, over-flexed or sour.
- Also credits should be noted on the card and reflected in the numerical score. Such as, athletic jumper, smooth, even pace, smooth round, pleasant attitude.
- While judging the hunter rounds, especially in large classes, keep a running tally of the high scoring rounds, or the rounds that may place. Mark down your top horses at the top or to the side of your card, or on a separate sheet, as you go, leaving space between numbers to insert numbers as the class proceeds. This will help facilitate matters and avoid delays when it comes time to jog and pin the class.

THE SCORECARD

PLACINGS

1	2	6
2	5	7
3	1	
4	4	
5	3	

SCORES

96-100 Excellent
 80-89 Good to very good / or an excellent horse with minor mistakes
 75-79 Average / or a good horse with minor mistakes
 60-69 Poor to below average performance/minor mistakes, no major faults
 50-59 One Major Fault: Head Knockdowns, Adding a stride in an In & Out, Very bad fence, Dropping a leg, Trotting on course, Cross center
 40-49 Serious Major Fault: Front knockdowns, Refusals, Extremely dangerous jumping
 30-39 Two or more Serious Faults
 10-29 Very Unsafe and Dangerous

0 - Elimination

JUDGE'S SIGNATURE

ENTRY NUMBER	FENCES & DESCRIPTION							IN-OUT 8 Stride 9	10	COMMENTS	MANEER PACESTYLE MOVEMENT	SCORES	JOG ORDER
	1	2	3	4	5	6	7						
1	✓	✓	✓	✓	✓	✓	✓	✓		> Bnt	FM	60	3
2	+	✓	✓	✓	✓	✓	✓	✓		+ front jump	EMT	86	1
3	✓	✓	✓	✓	✓	✓	✓	✓		Left on	GM	35	5
4	✓	✓	✓	✓	✓	✓	✓	✓		TT ch	PM	55	4
5	✓	✓	✓	✓	✓	✓	✓	✓		W. Lm.	GM	79	2
6	✓	✓	✓	✓	✓	✓	✓	✓		3 on	GM	33	6
7	✓	✓	✓	✓	✓	✓	✓	✓		TD	PM	30	7

WHAT THE (Optional) SCORECARD SAYS:

#1 Average mover, start score at 75, fence 2, good jump but uneven leg, score 72; fence 2, good, score 75; fence 3, horse chipped in, score 68; fence 4, good, score goes to 69; fence 5, one leg uneven, score 67; fence 6, good, a 69; counter-cantered to fence 7, good jump, but one leg lowered, score 55; fences 8 and 9, the in and out, good Final score: 60 (60-69 - poor, a below average performance, minor mistakes)

#2 Excellent mover, start score at 90. Fence 1, very good; fence 2 good, score 93; fence 3, good, but a hard front rub, score 91; plays around corner to fence 4, but jumps well, lower score to 86; fence 5, good, score 88; fence 6, very good, score 90; fence 7, hind rub, back to 89; fence 8, too close; fence 9, good. Final score: 86. (80-89 - Excellent horses with slight mistakes)

#3 Good mover, start score at 84, fence 1, good, fences 2 & 3 good, score 86, fences 4 & 5, good, up to 89; horse trots in corner, major fault, score 50; fence 6, good; fence 7, good;

fences 8 & 9, close, added a stride in the in & out. Final score: 35 (30-39 - Horses with two or more major faults)

#4 Poor mover, start score at 65; fence 1, hangs knees, score 63; fence 2, hangs knees, score 60; fence 3, good, score 63; fence 4, hangs knees, score 60; fences 5 & 6, good, score 65; fence 7, long, hangs knees, score 60; fence 8, long, hangs knees, score 55; fence 9, good. Final score: 55 (50-59- Major fault, very bad fences, very poor jumping style, dangerous style)

#5 A good mover, start score at 85; fence 1, good; fence 2, good; fence 3, good, but added a stride in the line, score 80; fences 4 & 5, good, score 82; fence 6, long, score 76; fences 7, 8 & 9, good. Final score: 79 (70-79 Good horses with slight mistakes)

#6 A good mover, start score at 85; fence 1, good but drifted to the right; score 83; fences 2, 3 & 4, good; score 88, counter canter to fence 5, jump good, but to the right, score 78; propped fence 6, a short spot, score 73; fence 7, long and reaching, score 69; fence 8, good; added a stride to fence 9, short spot and front

knockdown. Final score 33 (30-39- Two or more major faults)

#7 A fair mover, start score at 70; fence 1, refusal, then a deep spot, score 45; fences 2, 3 & 4, good, up to 49; fence 5, long with a front knockdown, score 39; cross-canthers to and scrambles over fence 6, dropping a leg, score 29; fences 7 & 8 good, score 33; fence 7, good but hind knockdown. Final score 30 (30-39 Two or more major faults)

JOG - Presidential Modification for 2021

- In all classes over obstacles, all horses being considered for an award must jog for soundness ~~in the judge's order of preference~~ prior to being judged for conformation. Two more entries than the number of ribbons must jog if there are sufficient entries.
- ***Horses are required to trot a circle on a loose rein at the end of each over fences performance.*** Horses may not leave the ring until the jog is declared official by the judge.
- A horse that leaves the ring prior to the jog being declared official will be eliminated.
- A horse that is unruly, one that breaks away from the handler or one whose actions threaten to endanger the rider, handler, other exhibitors or their entries will be eliminated. (Exception: Hunter Breeding and Pony Breeding).
- A horse may not be eliminated for receiving outside assistance in the jog.
- ***For conformation classes, horses shall return to the ring following the conclusion of all over fences performances in each class and line up in order of preference for conformation judging. Handlers must line horses up in compliance with social distancing guidelines.***

APPOINTMENTS

- Horses may be shown with a shortened, pulled or braided mane

and tail, however braiding is not required.

- Light hunter type bridles, snaffle, pelham and full bridle, all with cavesson nose bands are required. A judge may penalize, but not eliminate, at his own discretion, any horse with nonconventional snaffles, pelhams or full bridles including but not limited to hunter gags, kimberwicks etc. Judges must eliminate a horse that competes in bits other than snaffles, Pelhams or full bridles, and with nosebands other than cavesson nosebands. Illegal bits include, but are not limited to, three rings, gags, (except Hunter gag, defined as any snaffle bit with slots that can secure the reins, and/or cheek pieces of the headstall to the bit). Full Cheek snaffle bits with or without keepers are allowed. Illegal nosebands include, but are not limited to, drop, flash, tack and figure eight nosebands.
- The type of English saddle is optional, but forward seat saddle is recommended.
- Breastplate and/or martingale are optional. Exception: In Hunter Hack, Hunter Under Saddle and tie-breaking classes, martingales of any type prohibited.
- (Check Equine Canada Rules when judging in Canada.) Although martingales are permitted it is not desirable for the horse to use it aggressively, constantly pulling or pushing on it. The martingale should actually only be there for safety precautions.
- Boots or bandages on the horses are not permitted. In case of inclement weather, competition management may permit bell boots only.
- Informal attire of suitable material for hunting is required. It consists of conservatively colored coat of any tweed or Melton (conservative wash jackets in season) breeches (or

jodpurs) and boots. All riders in all Working Hunter classes must wear protective headgear. For rules regarding protective headgear (See AR111) For rules governing sidesaddle attire, see, HU-10.

- Spurs, whip, crop or bat is optional at the rider's discretion. Competitors are prohibited from carrying a whip that is longer than 30" (75cm) while competing or schooling over fences. A rider may not carry more than one whip. Whips weighted at the end are prohibited. Exception: Ladies Side Saddle and Appointments classes. See HU130.

THE COURSE

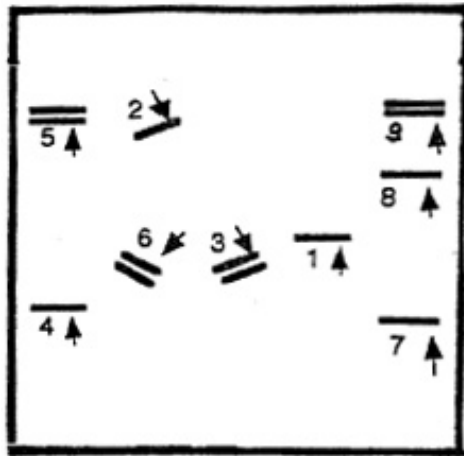

- Fence 1 Brush
- Fence 2 Board Gate
- Fence 3 Post and Rails Oxer
- Fence 4 Post and Rails
- Fence 5 Post and Rails Oxer
- Fence 6 Flower Box with Rail Oxer
- Fence 7 Small Wall with Rail
- Fences 8 & 9 Post and Rails In & Out

Distances must be marked on the course

Diagonal Line Fences 2 & 3,	72'- 5 strides
Outside Line Fences 4 & 5,	60'- 4 strides
Outside Line Fences 7 & 8,	48'- 3 strides
In and Out Fences 8 & 9,	24'- 1 stride

- A hunter course is made up of lines and curves, usually two straight outside lines, one or two diagonal lines, at least one change of direction and curving lines around the corners. This may vary a little with individual course designers, but, a hunter course should be set to allow the horse to maintain a steady, even pace, to jump on stride and in rhythm and show to the best of its advantage. Tricky courses are for the Jumper class.
- Since the working hunter class stems from fox hunting, fences must simulate those found in the hunt field. Stone or brick walls, gates, brush boxes, hedges, aikens, coops, rolltops, ascending oxers and post and rails, all in conservative colors, are acceptable types of fences.
- Fences should have ground lines or rails or a portion of the fence on the ground so the horse is able to accurately measure the height of the fence.
- Flowers, shrubs, cut greenery, flower boxes or other fillers may be used as ground lines or to fill an airy jump or too open a jump.
- A Hunter course shall be any course which management deems a fair test of a Hunter. For rules regarding type of fences, see Subchapter HU-3.
- Colorful jumps, striped rails, targets, hogs backs, triple bars and square oxers are prohibited in a hunter class. These types of fences are used for Jumper classes.
- Every course must have at least four-different types of fences and consist of at least eight jumping efforts on course. An in and out is considered as two separate fences in the required number and should be numbered separately.
- An in and out must never be used at the start of a course.
- The judge is not the course designer; however the judge is ultimately responsible for the course. Sometimes the people who set the course are not course designers either. Therefore, know which fences are allowed or not

allowed, how they should be set, check distances and be sure the course is safe and correct.

- Distances between the fences are determined as per USEF/USHJA Course Design guidelines and are based on the height of the fences, the desired number of strides to be taken between fences, the direction that the horses are jumping and arena conditions such as size and footing, indoor or outdoor. These distances are a guideline and course designers may alter based on conditions.
- The distances are measured from inside to inside, base to base, between fences.

TROUBLE SHOOTING LIST

THINGS TO DO BEFORE THE CLASS BEGINS

1. Obtain a copy of the course and make sure it is the same as the course posted for the competitors. Distances must be marked on the posted course diagram.
2. Inspect the course, preferably with the course designer. Check the following:
 - a. Distances in the lines and the combinations. (Strides)
 - b. Make sure all of the top elements (rails) are securely in their cups.
 - c. If any top rails are bowed, make sure they are bowed downward.
 - d. Check where the in and out gates are located.
 - e. Make sure all ground lines are on the correct side of the fences. (approximately 6" out from under the fence on the take-off side)
 - f. Make sure all oxers are ascending. (The back rail about 3" higher than the front rails. Only one rail, a top rail should be on the back set of wings of all oxers.)
 - g. Make sure all fences are proper hunter fences. No striped rails, hogsbacks, brightly painted colors, square oxers, targets, etc.
 - h. Remember, the judge, not the course designer, is ultimately responsible for the correctness and safety of the course.

i. Check lines of travel on approaches to and departures from each fence. Sometimes they look good on the course diagram, but are impossible to ride.

3. See where you are expected to judge from. Make sure you can see all of the fences from that point. If not, find a place to judge from where you can see everything. Usually from outside the arena.
4. Have a clipboard, score sheets, and a whistle. You are responsible for stopping a rider if necessary, by whistle, for resetting fences, unforeseen circumstances or when competitor is eliminated, the whistle also signals a rider to resume course.

HUNTER VOCABULARY - SO YOU CAN TALK THE LINGO

- **Distances:** number of feet between fences (usually multiples of 12; i.e. 24', 36', 48', ...) allowing a steady, even hunter pace and the correct number of strides.
- **Numbers:** number of strides between fences, not the numbers on the backs
- **Line:** two or more fences in a row, jumped consecutively without changing direction
- **Bending line:** two fences set on a line that curves
- **In and Out:** a combination, two jumps set with one stride (about 24') or two strides (about 36') in between
- **Course:** the designated direction of travel over the fences, basically lines and curves
- **Circle:** competitors are allowed one circle prior to beginning the course to establish a pace and may circle after finishing the course
- **Ground line:** a pole or other filler on the ground on the take off side of the fence, aids the horse in measuring the height of the fence
- **Filler:** brush, flowers, small walls or boxes, gates, etc. to fill in space between the ground and the top rail.

- **Airy jump:** a fence that does not touch the ground, or too much open space between the ground or the filler and the top rail (jump is deceiving and therefore unsafe)
- **Oxer:** spread fence, must be ascending with the front element lower than the back element, no triple bars in hunters
- **Vertical:** single, upright fence
- **Pace:** speed
- **Strides:** steps taken between fences, a normal stride is usually 12' when the horse is at a hunter pace (If the fences are set lower than 3' in height or the arena is small, strides may be shorter to compensate/ distances should be set shorter, too.)
- **Bascule:** good form, horse rounding the back while in the arc over the fence
- **Scope:** horse's jumping ability,
- **Refusals:** stops, run-outs, bolting past the jump, an added circle on the course
- **Showing or presenting the horse a fence:** riding to or allowing the horse to look at the fence without jumping it; counts as a refusal
- **Deep:** horse gets too close to the fence on the take-off
- **Long:** horse leaves the ground too far away from the fence on take-off
- **Chip:** adds a quick, abrupt, short stride just before jumping the fence
- **Props:** horse backs off, appearing to push itself away from the fence on the approach.
- **Twist:** horse's front end and rear end twist in opposite directions in the air
- **Drift:** horse jumps off to the right or to the left in the air
- **Quick:** leaving the ground quickly on take-off, or short, rapid strides before take-off
- **Diving:** stretching the legs far forward in order to clear the rails, severe form of reaching
- **Overflexed:** breaks in the middle of the neck, head behind the vertical, horse can't look ahead
- **Weaving:** not approaching the fence straight, veering left/right on approach to fence
- **See AR159 for Conduct, including Schooling and Jumping Order for Working Hunter**
- **See AR161 for Courses**
- **See AR162 for Height of Obstacles**
- **See AR163 for Appointments**
- **See AR164 for Working Hunter Class Specifications.**
- **See AR165 for Sections and Championships.**
- **See AR166 for how to break Championship Ties in Working Hunter**

WORKING HUNTER — Basic Course

IN-GATE



84'

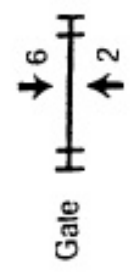

84'

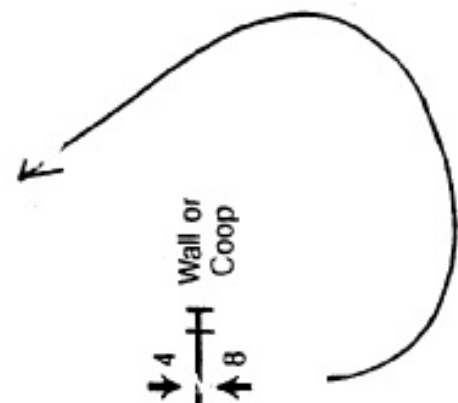

WORKING HUNTER — Modified Basic Course



60'



72'

84'

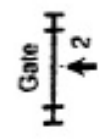

IN-GATE

Common Names Of Jumps



GATE

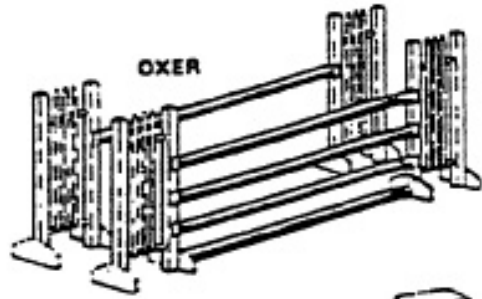

OXER

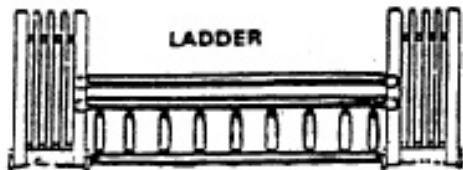

LADDER

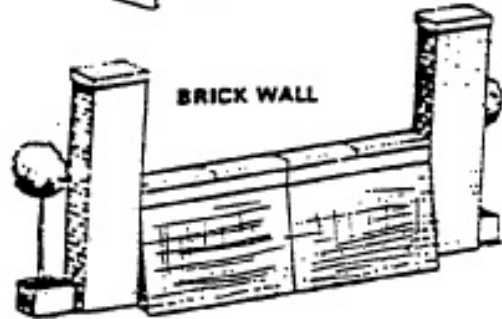

BRICK WALL



VERTICAL POST & RAIL

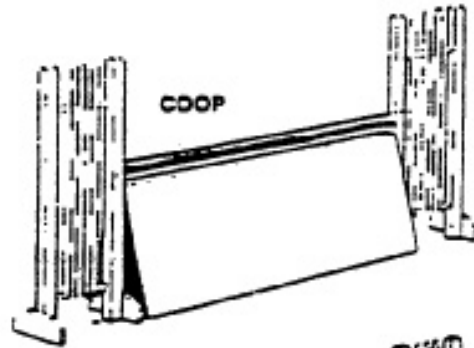

COOP

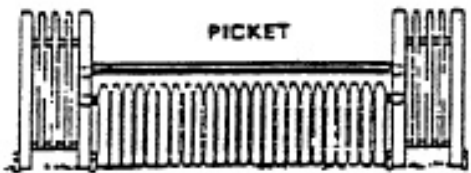

PICKET

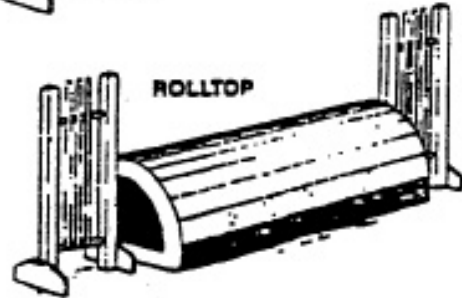

ROLLTOP



RIVIERA

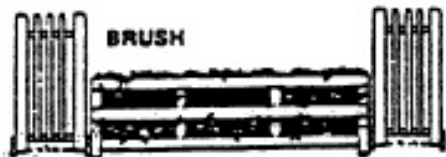

BRUSH

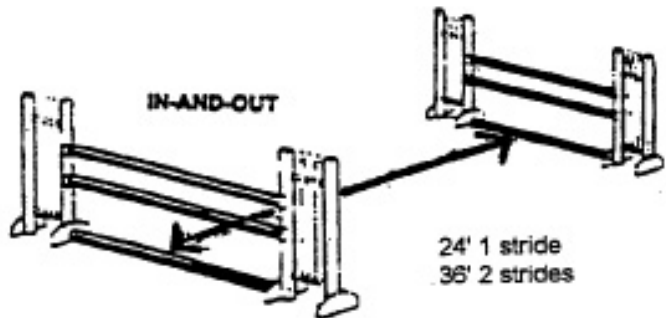

IN-AND-OUT

24' 1 stride
36' 2 strides

