



ARABIAN HORSE ASSOCIATION

Judges & Stewards

REINING

Table of Contents

GENERAL.....	1
DESCRIPTION.....	1
APPOINTMENTS.....	1
LEARNING TO JUDGE REINING HORSES.....	2
ITEMS TO CONSIDER BEFORE START.....	2
REINING SCORE SHEET/SCRIBE.....	3
REINING MANEUVERS.....	8
SCORING.....	11
PENALTIES.....	12
TIES.....	16
REINING HORSE DIAGRAMS.....	17

GENERAL

1.The Arabian reining horse section shall be conducted in accordance with the current NRHA Handbook as modified by the following Arabian rules. Where the Arabian rules are silent, NRHA rules prevail.

- a. There is no restriction on the number of horses a rider may show in a class.
- b. Equipment checks are to be conducted either by the (call) judge prior to leaving the arena or by the USEF Steward immediately outside of the performance arena after the run.
- c. Videotaping is required at AHA National Shows **AR214.5**. Regional Championships, East Coast and Pacific Slopes Championships, Canadian Nationals and all shows offering \$500.00 or more in reining section. See **AR214.5** for review procedures.
- g. Patterns must be posted **at least one hour prior to the start of the class. AR216.2 Effective 12/1/2023**
- h. **A Ten Point Penalty must be assessed for an unnatural tail carriage, AR 218 Effective 12/1/2023**

DESCRIPTION

- A. General. To rein a horse is not only to guide him, but also to control his every movement. The best reined horse should be willingly guided or controlled with little or no apparent resistance and dictated to completely.
- Any movement on his own must be considered a lack of control. All deviations from the exact written pattern must be considered a lack of/or temporary loss of control and therefore a fault that must be marked down according to severity of deviation.
- After deducting all faults, set here within, against execution of the pattern and the horse’s overall performance, credit should be given for smoothness, finesse, attitude, quickness and authority of performing various maneuvers, while using controlled speed which raises the difficulty level and makes him more exciting and pleasing to watch to an audience.
- The official guideline for the application for the rules for judging shall be as specified in the NRHA Judges Guide.

APPOINTMENTS

- For rules regarding correct attire and appointments, refer to **Working Western Subchapter AR 26, AR211 Appointments.**
- **See AR211.1d,h for Junior Working Western Horses tack restrictions.**
- Consider purchasing a NRHA Bit Gauge for checking bits. Order form link:



<https://nrha.com/media/pdf/2016/bitgauge.pdf>

LEARNING TO JUDGE REINING HORSES

- Many people have the ambition to become a good reining judge. You can learn to judge reiners if you think and make good use of your time in training.
- Learning to judge reining horses is not difficult, if you will learn to become a keen, careful observer. You will need to continuously practice distinguishing the differences in the various maneuvers and penalties.
- Attending NRHA Judges Seminar and scribing at NRHA events as well as Arabian events are good ways to further your knowledge and understanding of reining and how horses are scored.

CHARACTERISTICS OF A GOOD REINING JUDGE

1. Make accurate observations and focus on the variations in the performances of the horses.
 2. Weigh and evaluate the differences in maneuvers and compare them with the ideal characteristics and standards to that maneuver.
 3. The ability to recognize the penalties and evaluate their degree of severity.
 4. Arrive at a definite decision.
 5. Understand the mechanics of the reining system of judging and the scorecard and be able to communicate thoroughly to a scribe.
- Judging a reining class consists of making careful study of each horse and evaluate their performance by scoring each maneuver.
 - Each contestant will perform the required pattern individually and separately. The scoring of reining horses is on a positive numeric scale with 70 denoting an average performance.
 - After the horse begins its pattern the judge is responsible to analyze each maneuver and compare it to an ideal, then score the maneuver.
 - In addition, any time the horse incurs a penalty situation in its pattern, the judge must first recognize the penalty and then

apply the specific penalty points to that maneuver.

- At the conclusion of each contestant's performance the judge adds all maneuver scores to a beginning score of 70 to arrive at a gross score. All penalties are then subtracted from the gross score to determine the final score.
- NRHA has a Manuever Standards video that is downloadable.
<https://nrha.com/shop>

ITEMS TO CONSIDER BEFORE START

- Choose patterns, must be posted. Only patterns found in the current NRHA Handbook are used in reining classes at USEF/AHA Arabian competitions. Patterns are available on the NRHA website; the current NRHA Handbook and Pattern Book are also downloadable PDF files. **NRHA added two new reining patterns for 2024.** Short stirrup patterns are referenced with letters (A and B) not numbers.
- Ask management to prepare arena surface immediately prior to class. If entries warrant additional drags in intervals during class, ask that this be done. (Often experienced managers have already planned for this.)
- Request a scribe well before the class. If the volunteer has not scribed before you will need to spend some time and familiarize them with the judging system and the score sheet. See suggestions on Reining Notes document.
- Supervise placement of markers. (Markers are mandatory.) End markers should be a minimum of 50 ft. from the end of the arena. Center markers should be placed directly at center.
- **NOTE:** 50 feet is a minimum. Particularly in large arenas, this measurement should be greater. Markers are to ensure that everyone makes adequate runs; they are not devices to increase the degree of difficulty.

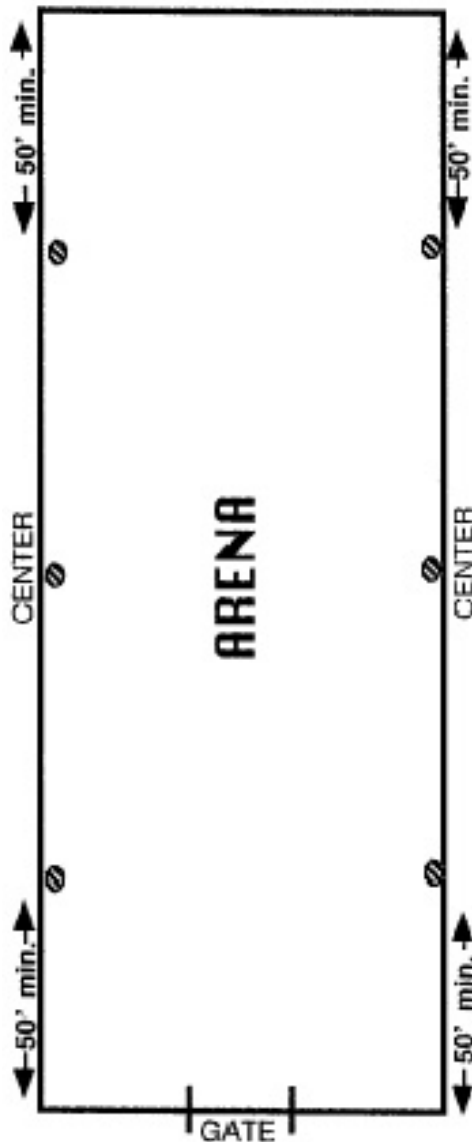

- If you prefer to have the USEF steward inspect bridles either before or after the run, ask him/her if they will do so.
- If you need to inspect bridles, know the correct procedures.
- If you are the only judge with no steward (AVS Shows), it will be your responsibility to check the equipment and the horse after each run.
- Prepare your score sheet in advance of the start of the class. Remember scores are announced after every run. An experienced scribe may prepare the score sheets for you; often competition management will furnish score sheets with maneuvers pre-printed; a downloadable form on AHA website.
- The judges' guide section of the current NRHA Handbook is a good source of information if you have a question about how to score a particular maneuver. Follow the equipment and attire rules in **AR 210.4**, not the NRHA or USEF Reining Chapter equipment and attire rules. The National Reining Horse Association website is www.nrha.com

REINING SCORE SHEET/SCRIBE

- It is management's responsibility to supply a scribe at every official event; however, it is the judge's responsibility to ensure that the scribe is properly trained prior to beginning the first run of the day.
- The judge must confirm that the scribe understands the fundamentals of recording both maneuver scores and penalty scores.
- It is recommended that judges verify that the addition of the maneuver scores and penalties is correct at the completion of the run.
- As part of the training process for the scribe, the judge should make certain that his/her communications are clear to the scribe.
- To ensure this clear communication, the judge and scribe should agree upon a method of speaking, so that maneuver scores and penalty scores are not confused (i.e., a judge will say a number for a maneuver score and will say "penalty" and a number for a penalty, thus allowing the scribe to place the appropriate score in the appropriate box on the score sheet).
- Scribes should be advised to record all scores and penalties in fractions as opposed to decimals to prevent errors in tabulating the final scores.

STEP 1 – Unless the information is already printed on the score sheet, write the name of the class and the class number, along with the date in the spaces indicated. Write the pattern number in the box indicated, if not pre-printed. Then, break the pattern down into maneuvers at the top of the score sheet, using abbreviations.

STEP 2 – When the rider enters the ring, enter the contestant’s number in the entry box.

STEP 3 - As each maneuver is completed, the judge will call a score to the scribe who will enter that score in the appropriate box. Scribes are to use a #2 or similar pencil. Scores that are not whole numbers are to be written as fractions, not decimals. Calculate the penalties along with the maneuver scores into the subtotal following each maneuver.

PATTERN #5	
Maneuver 1	Left Circles (LC or LC 20, 1o)
Maneuver 2....	Left Spins (LS or LS-4)
Maneuver 3....	Right Circles (RC or RC 20, 1o)
Maneuver 4....	Right Spins (RS or RS-4)
Maneuver 5....	Figure Eight (8)
Maneuver 6....	Stop & Rollback (RRB)
Maneuver 7....	Stop & Rollback (LRB)
Maneuver 8....	Stop & Back Up (S B)

(70 points +/- maneuver scores) – penalties = Score

REINING HORSE SCORE SHEET											PATTERN #	
CLASS _____			CLASS _____			DATE _____					5	
DRAW	ENTRY #	Penalty	1 Left circ.	2 Left spins	3 Right circ.	4 Right spins	5 Figure 8	6 Run stop R/B	7 Run stop L/B	8 Run stop back	PENALTIES	SCORE
1	101	Score	+ 1/2	0	+ 1/2	- 1/2	0	+ 1/2	0	0		
		Sub T										

STEP 4 - If a penalty occurs in the horse's performance the judge will call the correct penalty assessment to the scribe who will in return write that penalty down in the appropriate box. The judge will say “Penalty” in front of the number – example “Penalty half”

DRAW	ENTRY #	Penalty	1 Left circ.	2 Left spins	3 Right circ.	4 Right spins	5 Figure 8	6 Run stop R/B	7 Run stop L/B	8 Run stop back	PENALTIES	SCORE
1	101	Score		1			1/2		1/2			
		Sub T										

STEP 5 - At the completion of each work the scribe should add up all penalties and put the sum of the penalties in the appropriate box. A running total should be calculated per maneuver with the final score being put in the score box.

Draw	Entry #	Penalty		1			1/2		1/2		Penalties	SCORE
1	101	Score	+1/2	0	+1/2	-1/2	0	+1/2	0	0	2	69
		Sub T	70 1/2	69 1/2	70	69 1/2	69	69 1/2	69			

STEP 6 – Relay the score to the announcer; the score is to be announced before the next horse begins the pattern. If a score is being held for review, that will be announced as well.

STEP 7 - At the completion of the class, sign the score sheet and have a copy of the official score sheet posted. If multiple score sheets for the class, sign each sheet as it is completed.

EXAMPLES OF HOW THE REINING SCORE SHEET SHOULD LOOK:

Example #1

Entry #201:

1st Maneuver: Very Good

2nd Maneuver: Good

3rd Maneuver: Very Good

4th Maneuver: Good

PENALTY: Over spin up to 1/8 turn

5th Maneuver: Correct

PENALTY: Out of lead 1/4 circle.

6th Maneuver: Good

7th Maneuver: Good

8th Maneuver: Very Good

Your score sheet should look like this:

Draw	Entry #	Penalty				1/2	1				Penalties	SCORE
1	201	Score	+1	+1/2	+1	+1/2	0	+1/2	+1/2	+1	1 1/2	
		Sub T	71	71 1/2	72 1/2		71 1/2	72	72 1/2	73 1/2		73 1/2

Example #2

Entry #202:

1st Maneuver: Good

2nd Maneuver: Very Good

3rd Maneuver: Good

4th Maneuver Excellent

5th Maneuver: Good

6th Maneuver: Good

7th Maneuver: Very Good

8th Maneuver: Very Good

Your score sheet should look like this:

DRAW	ENTRY #	Penalty	1	2	3	4	5	6	7	8	PENALTIES	SCORE
2	202	Score	+ 1/2	+ 1	+ 1/2	+ 1 1/2	+ 1/2	+ 1/2	+ 1	+ 1		76 1/2
		Sub T	70 1/2	71 1/2	72	73 1/2	74	74 1/2	75 1/2	76 1/2		

NOTE: This would be a great run!

Example #3

Entry #203:

1st Maneuver: Correct
 2nd Maneuver: Poor
 PENALTY: Under spin ¼ turn.
 3rd Maneuver: Correct
 4th Maneuver: Poor

5th Maneuver: Correct
 PENALTY: Out of lead ¾ circle.
 6th Maneuver: Poor
 7th Maneuver: Very Poor
 8th Maneuver: Very Poor

Your score sheet should look like this:

Draw	Entry #	Penalty		1		3				Penalties	SCORE	
3	203	Score	0	-1/2	0	-1/2	0	-1/2	-1	-1	4	62 1/2
		Sub T	70	68 1/2		68	65	64 1/2	63 1/2	62 1/2		

Example #4

Entry #204:

1st Maneuver: Correct
 2nd Maneuver: Correct
 3rd Maneuver: Correct
 4th Maneuver: Correct
 5th Maneuver: Correct

6th Maneuver: Good
 PENALTY: Exit Rollback at Jog, up to 2 strides
 7th Maneuver: Good
 8th Maneuver: Good

Your score sheet should look like this:

Draw	Entry #	Penalty					1/2			Penalties	SCORE	
4	204	Score	0	0	0	0	0	+1/2	+1/2	+1/2	1/2	71
		Sub T	70					70	70 1/2	71		

Example #5

Entry #205:

1st Maneuver: Correct
 2nd Maneuver: Poor
 PENALTY: Over spin 1/4 turn
 3rd Maneuver: Correct
 4th Maneuver: Correct

5th Maneuver: Correct
 6th Maneuver: Extremely Poor
 PENALTY: Held Saddle
 7th Maneuver: Very Poor
 8th Maneuver: Very Poor

Your score sheet should look like this:

Draw	Entry #	Penalty		1			5			Penalties	SCORE	
5	205	Score	0	-1/2	0	0	0	-1/2	-1	-1	6	
		Sub T	70	68 1/2				62	61	60		60

Example #6

Entry #206:

1st Maneuver: Correct
 2nd Maneuver: Correct
 3rd Maneuver: Correct
 PENALTY: Out of Lead 1/4 circle.
 4th Maneuver: Good
 PENALTY: Over-spin 1/8 turn.

5th Maneuver: Correct
 6th Maneuver: Good
 7th Maneuver: Correct
 PENALTY: Out of Lead at corner, corrected prior to top of arena.
 8th Maneuver: Good

Your score sheet should look like this:

Draw	Entry #	Penalty		1	1/2			1		Penalties	SCORE	
6	206	Score	0	0	0	+1/2	0	+1/2	0	+1/2	2 1/2	
		Sub T	70		69	69		69 1/2	68 1/2	69		69

Example #7

Entry #207:

1st Maneuver: Poor
 PENALTY: Out of Lead 2 complete circles.
 2nd Maneuver: Poor
 3rd Maneuver: Correct
 4th Maneuver: Poor
 5th Maneuver: Correct
 PENALTY: Delay of Lead change by one stride.

6th Maneuver: Poor
 PENALTY: Missed Marker
 PENALTY: Exit Rollback at Jog, over 2 strides
 7th Maneuver: Poor
 PENALTY: Failure to maintain 20' distance from wall or fence when approaching stop.
 8th Maneuver: Poor

Your score sheet should look like this:

Draw	Entry #	Penalty	8			1/2	2, 2	1/2		Penalties	SCORE	
7	207	Score	-1/2	-1/2	0	-1/2	0	-1/2	-1/2	-1/2	13	
		Sub T	61 1/2	61		60 1/2	60	55 1/2	54 1/2	54		54

NOTE: As unlikely as it may seem, runs like this do happen!

Example #8

Entry #201:

1st Maneuver: Good .

2nd Maneuver: Good
 3rd Maneuver: Correct

4th Maneuver: Good
 PENALTY: Zero Score (5 spins)

PENALTY: Out of lead ½ circle
 6th Maneuver: Good
 7th Maneuver: Good
 8th Maneuver: Correct

5th Maneuver: Poor

Your score sheet should look like this:

Draw	Entry #	Penalty				0	2				Penalties	SCORE
8	208	Score	+1/2	+1/2	0	+1/2	-1/2	+1/2	+1/2	0	0	0
		Sub T	70 1/2	71		0						0

NOTE: Always continue to score a run, even after a Zero core penalty has been accrued.

REINING MANEUVERS

- Judges are required to score a reining horse based on its execution of the various maneuvers required in a pattern.
- All horses will be judged immediately upon entering the arena and judging will cease after the last maneuver.
- Any fault incurred prior to the commencement of a pattern will be scored accordingly.
- Remember, scoring is on a positive numeric scale with 70 denoting an average performance.
- Each pattern is divided into 7 or 8 maneuver groups. These maneuver groups are comprised of the following maneuvers:

appearance of intimidation including walking, stopping or checking is a fault which shall be marked down according to the severity in the first maneuver score.

- Failure to jog the majority of the way to the center will result in a 0 for failure to complete the pattern as written.

STOPS

- Stops are the act of slowing the horse from a lope to a stop position by bringing the hind feet and hocks under the horse in a locked position and sliding on the hind feet.
- The horse should enter the stop position by bending the back and bringing the hind legs further under the body while maintaining forward motion and ground contact and cadence with front legs.
- Throughout the stop, the horse should continue in a straight line while maintaining ground contact with the hind feet.
- For purposes of marker penalties, the stop position is defined as rear legs up underneath, setting up

WALK-IN

- The walk-in brings the horse from the gate to the center of the arena to begin its pattern. The horse should appear relaxed and confident.
- Any action which may create the appearance of intimidation including starting and stopping, or checking is a fault which shall be marked down according to the severity in the first maneuver score.

JOG-IN

- Horses must jog the majority (over ½ the distance) of the way to the center. The horse should appear relaxed and confident.
- Any action which may create the

SPINS

- Spins are a series of 360-degree turns, executed over a stationary (inside) hind leg. Propulsion for the spin is supplied by the outside rear leg and front legs, and contact should be made with the ground and a front leg.

- The location of the hindquarters should be fixed at the start of the spin and maintained throughout the spins.
- It is helpful for a judge to watch for the horse to remain in the same location, rather than watching for a stationary inside hind leg. This allows for easier focus on other elements of the spin (i.e., cadence, attitude, smoothness, finesse, and speed.)

ROLLBACKS

- Rollbacks are the 180 degree reversal of forward motion completed by running to a stop, rolling (turning) the shoulders back to the opposite direction over the hocks and departing in a lope, as one continuous motion.
- The NRHA Handbook states no hesitation; however, a slight pause to regain footing or balance should not be deemed

hesitation. The horse should not step ahead or backup prior to the rollback.

CIRCLES

- Circles are maneuvers at the lope, of designated size and speed, which demonstrate control, willingness to guide, and degree of difficulty in speed and speed changes.
- Circles must at all times be run in the geographical area of the arena specified in the pattern description and must have a common center point.
- There must be a clearly defined difference in the speed and size of a small, slow circle and a large, fast circle.
- Also, the speed and size of small, slow right circles should be similar to small, slow left circles; and the speed and size of large, fast right circles should be similar to large, fast left circles.

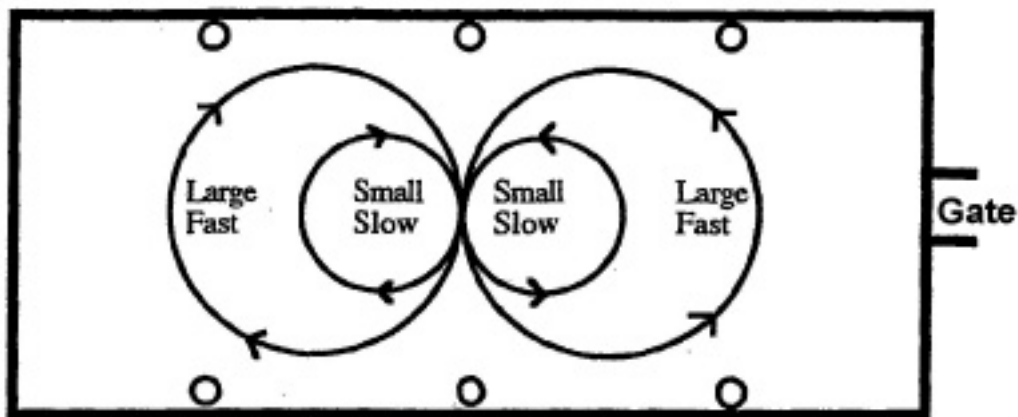

Ideal Circles.

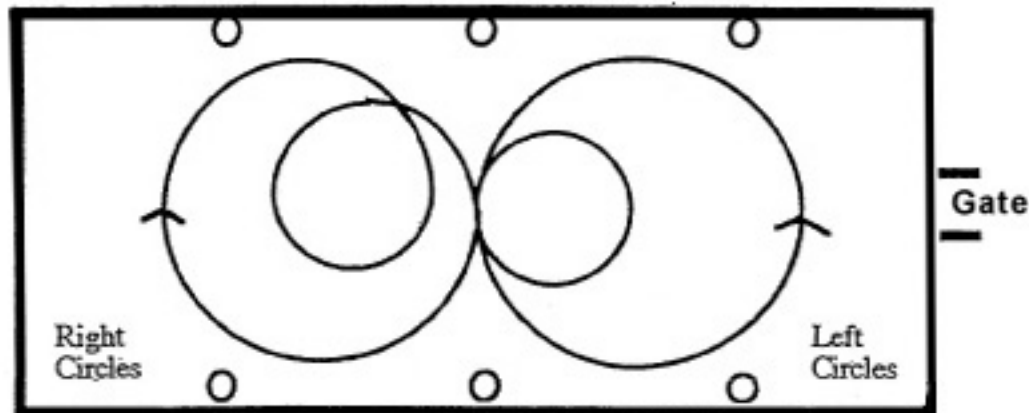

Left and Right Circles Do NOT Share a Common Center Line:

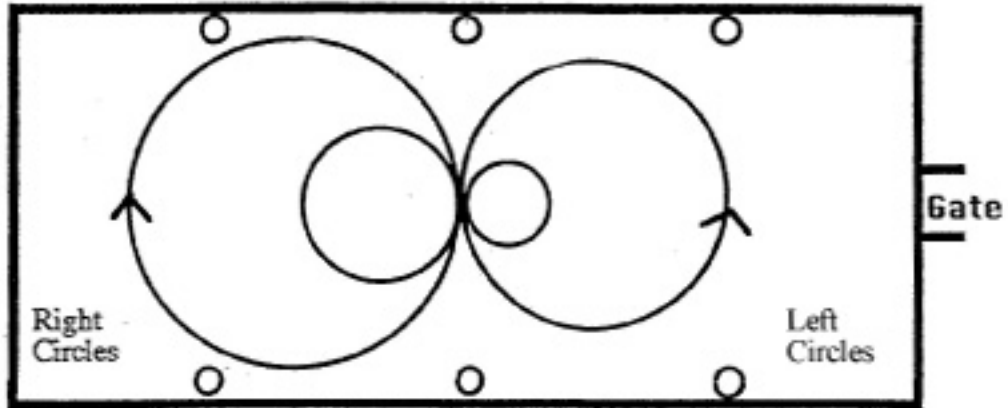

Left and Right Circles are NOT the Same Size.

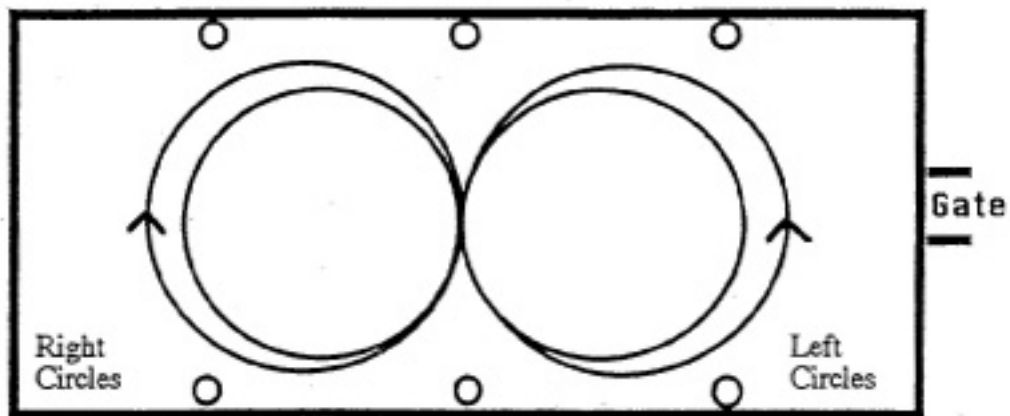

Both Sets of Circles Do Not Show Enough Difference in Size Between Large and Small Circles

BACKUPS

- A back up is a maneuver requiring the horse to be moved in a reverse motion in a straight line a required distance; at least 10 feet.

HESITATE

- To hesitate is the-act of demonstrating the horse's ability to-stand in a relaxed manner, at a designated time in the-pattern. All NRHA patterns require a hesitation at the end of the final maneuver to indicate to the judge(s) the completion of the pattern.

LEAD CHANGES

- Lead changes are the act of changing the leading legs of the front and rear pairs of legs, at a lope, when changing the direction traveled. The lead change must be executed at the lope with no change of gait or speed and be performed in the exact geographical location in the arena specified in the pattern description. The change of front and rear leads must take place within the same stride to avoid penalty.

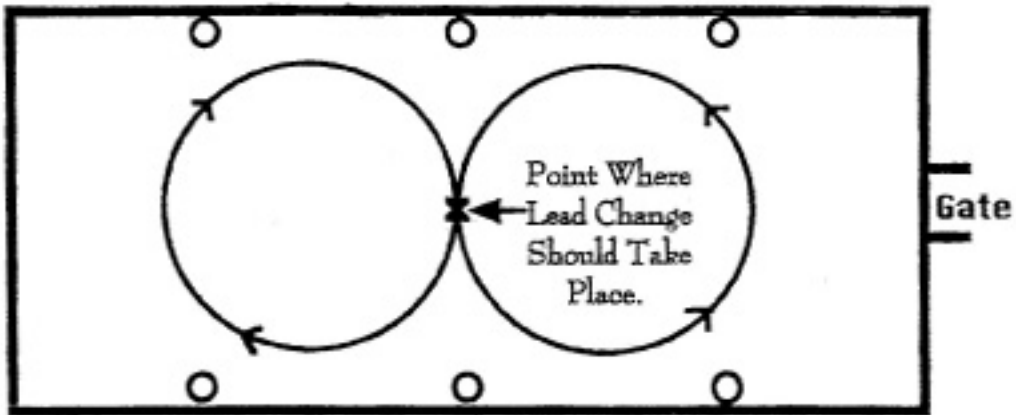

RUN DOWNS AND RUN-AROUNDS

- Run downs are runs through the middle of the arena (A & B) and runs along the side and ends of the arena (C). Run downs and run-arounds should demonstrate control and gradual increase in speed to the stop.

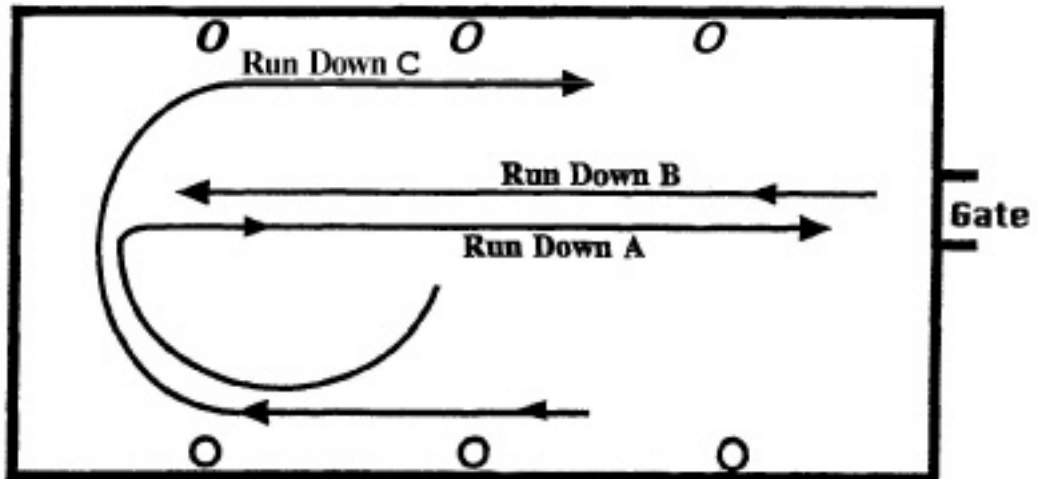

SCORING

- The scoring will be on a basis of 0-Infinity, with 70 denoting an average performance. Scores will be announced after each horse works. The individual maneuvers are scored in 1/2 point increments from a low of -1 1/2 to a high of +1 1/2 with a score of 0 denoting a maneuver that is correct with no degree of difficulty. Scores will be announced after each horse works.
- Individual maneuver scores can range in

half point increments from +1 1/2 to -1 1/2 with each increment denoting the following:

- +1 1/2 excellent
- +1 very good
- + 1/2 good
- 0 correct
- 1/2 poor
- 1 very poor
- 1 1/2 extremely poor

- In order to make an accurate assessment

as to which score is appropriate for a particular maneuver group a judge must take into consideration the following hierarchy of concerns:

1. ON PATTERN - The judge must ensure that the maneuver being performed by horse and rider is the correct maneuver as dictated by pattern.

2. CORRECTNESS - Having ascertained that the horse and rider are performing the maneuver required by the pattern, the judge must then ascertain whether the maneuver is being executed correctly. In this regard, the judge must evaluate the performance of the maneuver against the requirements of the maneuver descriptions listed in this guide. In each group of maneuvers, the judge must ascertain that the horse has been dictated to completely and the basic elements of the maneuver have been fulfilled regardless of the degree of difficulty. In the instance where horse and rider have failed to correctly perform the maneuver, the judge will deduct for a substandard performance. This deduction ranges from -1/2 to -1 1/2 for the maneuver

3. DEGREE OF DIFFICULTY - Having ascertained that the horse and rider are on pattern and have performed the maneuver group correctly, a judge must evaluate the degree of difficulty in completing the maneuver. In the instance where the horse has correctly performed the maneuver and has exhibited some degree of difficulty, a judge will assess the degree of difficulty on a scale of +1/2 to +1 1/2. Credit for degree of difficulty should be given for using smoothness, finesse, attitude, quickness, authority and controlled speed while completing a correct maneuver.

- It is recommended that a judge use the same scale for evaluating a maneuver, regardless of the level of competition at an NRHA event and regardless of ground and other conditions.
- When utilizing the above scoring methodology, it is critically important that

a judge evaluate the entire maneuver group. For example, in maneuver six of pattern eight, a judge is required to evaluate all of the following:

- (a) the run around the end of the arena
- (b) the approach to the stop
- (c) the stop
- (d) the rollback
- (e) the exit from the rollback

PENALTIES

NO SCORES

- **The following will result in result in no score:**

- a. infraction of any state or federal law which exists pertaining to the exhibition, care and custody of horses within the state or country where the class is being held.
- b. abuse of animal in show arena and/or evidence that an act of abuse has occurred prior to or during the exhibition of a horse in competition; includes lameness, fresh blood in mouth, chin, shoulder, barrel, flank, or hip area – those areas reasonable to believe the injury may have been caused by the rider or equipment – must be considered abuse regardless of how the injury was caused.)

Obvious lameness is a clearly evident gait deficit which is: (a) Consistently observable at a jog under all circumstances and/or (b) Obvious at a walk and/or (c) Minimal weight bearing in motion and/or rest or a complete inability to move.

- (i) If the judge(s) determines paint or other substance has been applied to a horse to disguise abuse he/she may call a no score.

NOTE: changing the color of the hide or hair or using anything other than clear grooming materials is a violation of Arabian rules.

- c. use of illegal equipment, including wire on bits, bosals or curb chains;
- d. use of illegal bits, bosals or curb chains;

- e. use of tack collars, tie downs or nose bands;
- f. use of whips or bats;
- g. use of any attachment which alters the movement of or circulation to the tail;
- h. use of belly bands, belly wraps, or other materials wrapped around the belly.
- i. failure to dismount and/or present horse and equipment to the appropriate judge (*or steward*) for inspection;
- j. In any approved class, the judge shall have the authority to require the removal or alteration of any piece or equipment or accoutrement which is unsafe, or in his/her opinion, would tend to give a horse an unfair advantage or which he/she believes to be inhumane;
- k. disrespect or misconduct by the exhibitor
- l. The judge(s) may excuse a horse at any time while in the arena for unsafe conditions or improper exhibition pertaining to either the horse and/or rider.
- m. closed reins are not allowed except as standard romal reins and mecates on snaffle bits and bosals in classes where the use of two hands is allowed and in Youth 10 & Under Short stirrup class where closed reins are allowed.
- n. Use of Bluetooth headsets or electronic devices, excluding para reining

NOTES:

- Excess rein may be straightened anytime during the pattern, provided the rider's free hand remains behind the rein hand.
- Any attempt to alter tension or length of the reins from bridle to the rein hand is to be considered use of two hands and a penalty score of zero will be applied.
- In addition, should the judge determine the free hand is being used to instill fear or praise, a penalty five will be applied, and a reduction in the maneuver score.
- When using a romal, the romal reins can only pass through the hand once.

- Straightening the rein anytime during the pattern, as defined above, applies to riders using split reins or romal reins.
- Rider is allowed to untangle or straighten horse's mane at any place a horse is allowed to be completely stopped during the pattern.

ZERO SCORE PENALTIES

- **The following will result in a score of 0 (zero):**
 - a. use of more than index or first finger between reins when using split reins; use of any finger between reins when using romal reins
 - b. use of two (2) hands (exception: snaffle bit or hackamore classes designated for two hands) or changing hands. Excess rein [split reins or romal reins) may be straightened anytime during a pattern, provided the rider's free hand remains behind the rein hand.
 - c. use of romal other than as outlined in the rules;
 - d. failure to complete pattern as written;
 - e. performing the maneuvers other than in specified order; or exceeding greater than one quarter of the circle out of order. (i.e. when a horse begins circles in the wrong direction for more than a quarter of a circle before changing direction; when a small slow and large fast circles are required, and the horse runs a large fast and small slow and large fast set of circles, or when it requires a large fast, a lead change and a small slow and the horse runs a large fast, does a lead change and then continues over one quarter of the next circle in a large fast)
 - f. the inclusion of maneuvers not specified, including but not limited to
 - (1) backing more than two (2) strides (*4 steps = 2 strides – count the FRONT steps*)
 - (2) turning more than ninety (90) degrees
 - (3) on run in patterns, once beginning a lope a complete stop prior to reaching the first marker. (Exception: a complete stop in the 1st quarter of a circle after a

- lope departure is not to be considered an inclusion of maneuver; a two (2) point break of gait penalty will apply.)
- g. equipment failure that delays completion of pattern,
 - h. balking or refusal of command where performance is delayed
 - i. running away or failing to guide where it becomes impossible to discern whether the entry is on pattern;
 - j. jogging in excess of one-half (1/2) circle or one-half (1/2) the length of the arena while starting a circle, circling or exiting a rollback;
 - k. overspins of more than one quarter (1/4) turn;
 - l. fall to the ground by horse or rider. A horse is deemed to have fallen when its shoulder and/or hip and/or underline touches the ground.
 - m. dropping a rein that contacts the ground while the horse is in motion.
 - n. failure to wear appropriate western attire as outlined in the Arabian rules. Western attire may include protective headgear (ASTM/SEI).
 - o. when going to and coming out of a rollback in a pattern requiring a run-around, a rollback that crosses the center line

NOTE: Neither a no score nor a zero (0) is eligible to place in a go round nor single go round class. Neither a no score nor a (0) may advance in a multi-go event.

- In multi go events, finals qualifying horses that get a (0) or scratch will still be eligible for payouts, with a (0) placing higher than a scratch.
- In the event not enough horses qualify for total purse distribution, the undistributed portion of the purse will be retained by competition management.

10-POINT PENALTIES

A Ten Point Penalty must be assessed for an unnatural tail carriage, see AR105.2bii Effective 12/1/2023

5-POINT PENALTIES

- **The following will result in a five point penalty:**
 - a. spurring in front of cinch;
 - b. use of either hand to instill fear or praise;
 - c. holding saddle with either hand;
 - Exceptions:
 1. Freestyle Reining
 2. Youth 10 & Under Short Stirrup class
 3. Age 65 and older (Non Pro classes only, excluding Categories 2 and 6. Age as of January 1).
 - d. the act of a horse dropping to its knees or hocks (In order to assess the 5-point penalty correctly, an important distinction must be made. A horse that hits its hocks while performing a sliding stop should not receive the penalty and should not be confused with the horse that drops to its hocks at the completion of the stop due to a clear loss of balance or a horse that sits down should receive the penalty 5. To assess the 5-point penalty correctly during spins, an important distinction must be made. A horse that turns with its hock touching the ground should not receive the penalty 5 and should not be confused with the horse that drops to its hocks due to a clear loss of balance which should receive the penalty 5.
 - e. blatant disobedience including, but not limited to, kicking, biting, bucking, rearing and striking.

2-POINT PENALTIES

- **The following will result in a two-point penalty:**
 - a. Break of gait. Note: Simple change of leads are allowed in Green classes; no break of gait penalty should be applied during the lead change.
 - b. Freezing up in spins or rollbacks.
 - c. On walk-in patterns, loping prior to reaching the center of the arena and/or

failure to stop or walk before executing a lope departure.

d. On run-in patterns, failure to be in a lope prior to reaching the first marker or break of gait prior to the first marker.

e. If a horse does not completely pass the specified marker before initiating a stop position.

- **Starting or performing circles or eights out of lead:**
 - a. Each time a horse is out of lead, a judge is required to penalize by 1 point. The penalty for being out of lead is cumulative, and the judge will add 1 penalty point for each 1/4 of the circumference of a circle or any part thereof that a horse is out of lead. A delayed change of lead is a one (1) point penalty from one stride to 1/4 of circumference of a circle and is also cumulative beyond that point.
 - b. A judge is required to penalize a horse 1/2 of a point for a delayed change of lead by 1 stride where the lead change is required by the pattern description.
- **Rollbacks & starting a circle:** Deduct 1/2 point for starting circle at a jog or exiting rollbacks at a jog up to 2 strides. Jogging beyond 2 strides but less than 1/2 circle or 1/2 the length of the arena, deduct 2 points.
- **Spins:** Deduct one-half (1/2) point for over or under spinning up to one-eighth (1/8) of a turn; deduct one (1) point for over or under spinning up to one-quarter (1/4) of a turn. A horse can only be assessed one over or under spin penalty per maneuver.
- **Run-arounds:** In patterns requiring a run-around, failure to be on the correct lead when rounding the end of the arena will be penalized as follows:
 - a. From the turn to the half-way position at the end wall – one (1) point
 - b. Beyond the half-way point to the beginning of the run down – two (2) points
- **Wall Penalty:** There will be a half point penalty for failure to remain a minimum of

20 feet from the side of the arena when approaching a stop and/or rollback.

- **Center Penalty:** In patterns requiring a run-around, there will be a ½ point penalty for failure to remain a minimum of 10' from either side of the center of the arena; for small arenas it will be at the judge's discretion.
- **Stumbles:** A horse which severely stumbles, significantly detracting from the maneuver, shall have the maneuver reduced by one half (1/2) point.
- Judges may not confer as to any penalty or maneuver score prior to submitting a score.
- If a major penalty (a penalty which results in a no score, a zero (0), a two (2) point, or a 5 point penalty) is unclear, a judge will submit his/her score and ask that the score be held, pending a conference and/or review of the official video at the earliest appropriate time.
- Should the judges determine via conference or official video replay that a penalty was incurred, it should be applied. If, however, no penalty occurred, the score will be announced as originally submitted.
- No judge shall be required to change his/her score following a conference or official video replay.
- Each judge's decision is an individual call and based on individual decision from a conference or official video replay.
- The use of official video equipment by the judges is only permissible if the judge has reason to believe that all entries have been videotaped.
- Judges will be allowed to review 2-point penalties for break of gait, jogging more than two (2) strides and freeze ups. Upon the review of a major penalty, if the major penalty is deemed to not have occurred, the judge has the ability to add the appropriate penalty.
- Judges must continue to score no scores and penalty score 0 scores in a multiple judged or videotaped event in the event of a review. It is suggested that each judge continue to mark runs whenever possible.

- The judge shall have the authority to remove any contestant from a competition he is judging, should said contestant show any disrespect or misconduct as to render himself or the competition in an unprofessional manner.
- Equipment checks are to be conducted either by the (call) judge prior to leaving the arena or by the USEF Category 2 Steward immediately outside of the performance arena after the run.
- Should the equipment judge detect cause for a no score, the exhibitor or his/her representative, trainer, or guardian may at that time accept the no score and allow the equipment judge to cause the appropriate changes to all score cards or request the other judges confer on the appropriate call.
- In the case of a youth exhibitor, should a parent, trainer, or guardian not be present, it will be assumed that all parties are aware of this rule and agree to abide by the exhibitor's decision. If requested, the equipment judge will confer with the other judges as soon as practical. Failure to comply with this rule will result in a no score.
- Judges shall be the sole person responsible to determine if a rider has correctly completed the pattern as written.
- An exhibitor or owner in the respective class may request a review of a major penalty [penalty score zero (0), a two (2) point or a five (5) point penalty]. The judge(s) has the right to deny or honor the request. If honored by the judge(s) he/she must believe the entire class was videotaped by an official videographer. The request must be made no later than thirty (30) minutes after the last run of the day and before the judge(s) has left the grounds for the day. In cases where a class is run in sections over multiple days, each day's scores will be official thirty (30) minutes after the last run of each section. Exhibitors or owners may not have direct contact with the judge(s) during the entire process of requesting a review. The request must be submitted to the Show Steward, or if need be, Show management, who will take the request to the judge(s).
- NRHA permits the judge the option of awarding a re-ride if an unavoidable circumstance disrupts a horse and rider's pattern. In the instance where a re-ride is warranted in the judge's opinion, the judge should advise the USEF steward, and/or horse show management of such as soon as possible. In the case where a horse was able to complete the pattern, but a re-ride is warranted, the score should be held until the rider decides whether to exercise the re-ride option.
- **NOTE:** All horses will be judged immediately upon entering the arena and judging will cease after the last maneuver. Any fault incurred prior to the commencement of a pattern will be scored according to the rules for judging.
- There are allowances for Para-Reining – see NRHA Rulebook for details.
- Read the Judges' Guide that is part of the NRHA Handbook.

TIES

- ***Refer to AR214.4 for ties.***

REINING HORSE DIAGRAMS

Run in pattern penalties

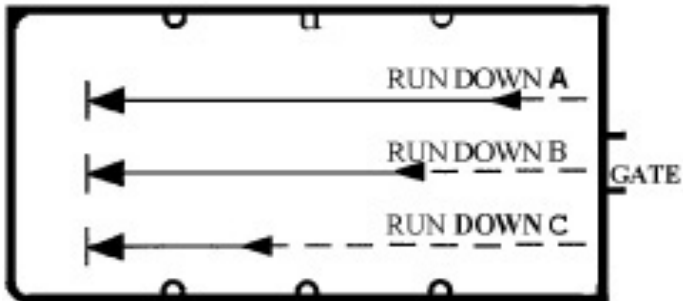

RUN DOWN A -
 Jogging is allowed prior to loping, as long as horse is in a lope before reaching the first marker.
NO PENALTY

RUN DOWN B -
 Failure to be in a lope prior to reaching the first marker.
2 POINT PENALTY

RUN DOWN C -
 Jogging an excess of 1/2 the arena length.
ZERO SCORE

Walk in pattern penalties

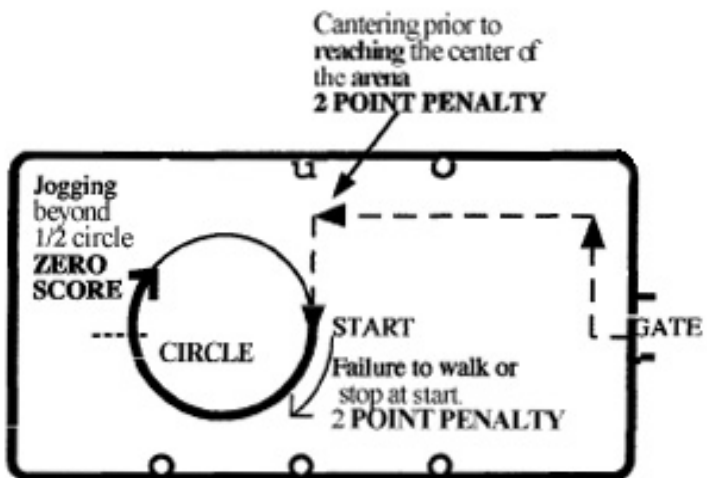

A. Cantering prior to reaching the center of the arena **and/or** failure to walk or stop before executing a lope departure - **2 POINT PENALTY**

B. Jogging in excess of 1/2 circle - **ZERO SCORE**

REINING HORSE DIAGRAMS

Out of Lead Penalties I

Delayed lead changes by one stride will only be penalized 1/2 POINT. After one stride the correct penalty assessment will be 1 point for each 1/4 circumference of a circle traveled.

NOTE: This may occur by being disunited (different leads in front and back) for one stride or by distance traveled (traveling one stride outside of designated area to change leads).

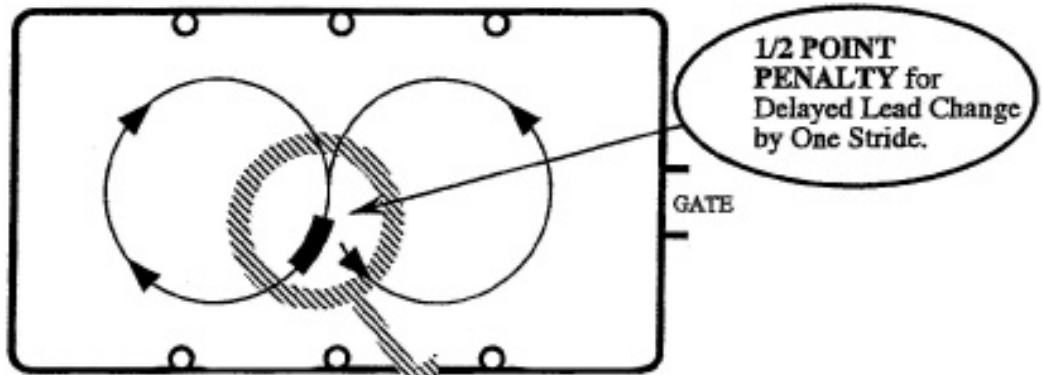

EXPLANATION:

A horse's stride is approximately 12 feet. Horses should be given an acceptable area equal to the distance of one stride (12') either side of the center line (a total distance of 24') to make a lead change without penalty, unless the horse is disunited for one stride. If the change is completed cleanly within one stride (12') beyond the acceptable distance a 1/2 point penalty applies

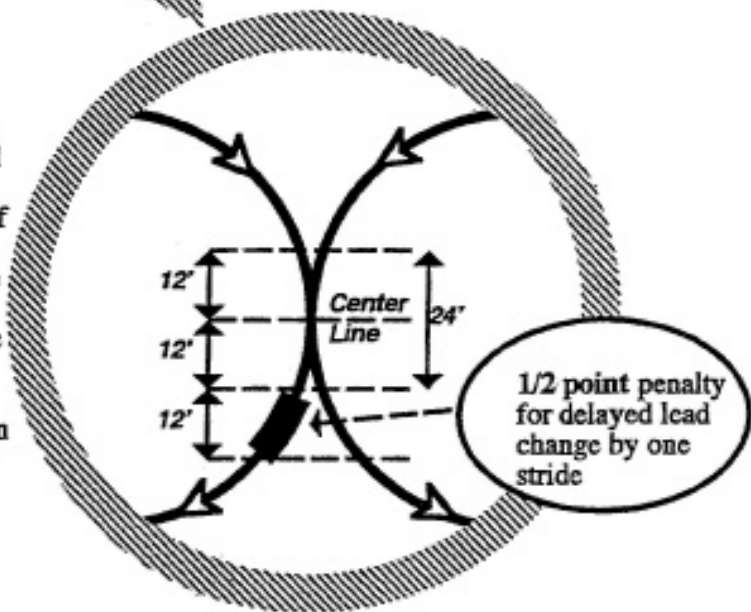

REINING HORSE DIAGRAMS

Out of Lead Penalties II a

Starting, performing circles or figure eights out of lead will be penalized 1 POINT (accumulative) for each quarter circle out of lead.

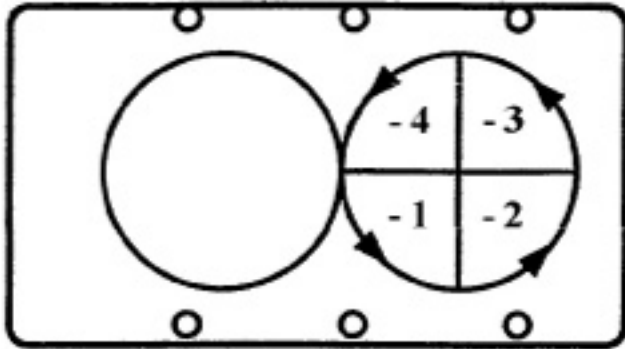

Example A
One circle each side.

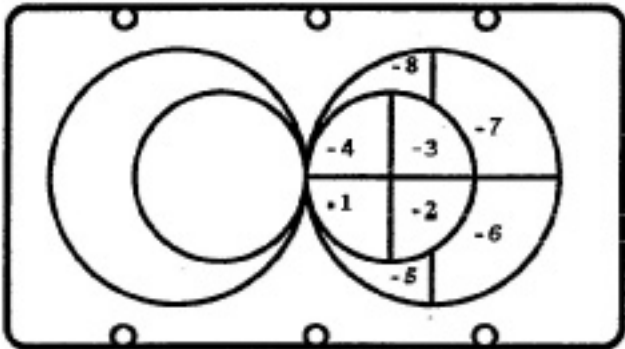

Example B
Two circles each side.

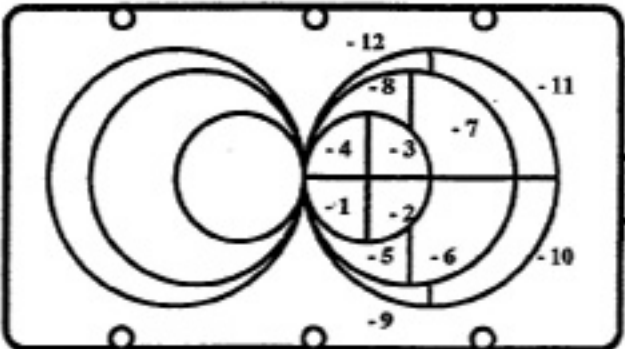

Example C
Three circles each side.

REINING HORSE DIAGRAMS
Part 5

Out of Lead Penalties II a (cont.)

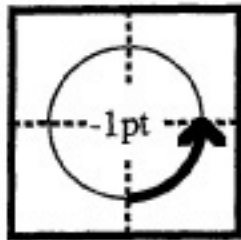
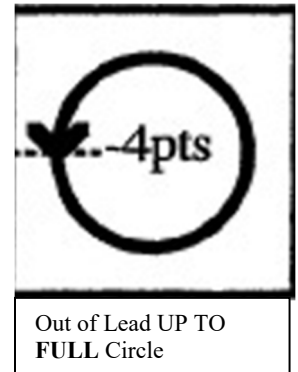
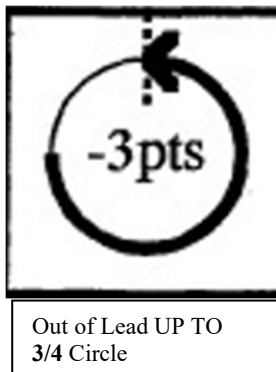
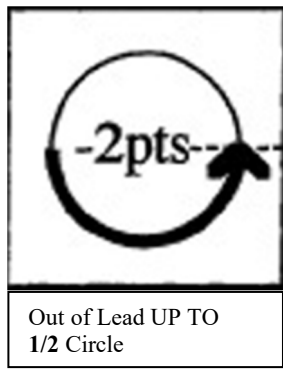
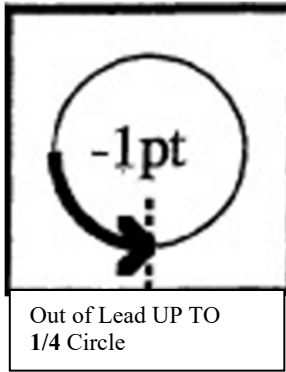

Out of Lead Up to a 1/4 Circle. Although it is in the Second Quarter.

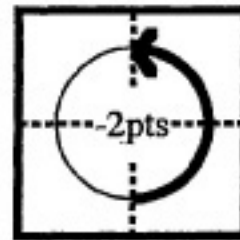

Out of Lead Up to a 1/2 Circle. Although it is in the Second & Third Quarters.

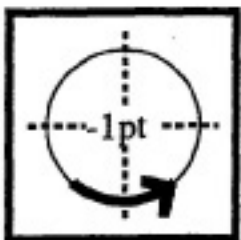

Although This Diagram Indicates a Horse ~~Out~~ of Lead in Two Different Quarters of the Circle, the Distance Traveled Out of Lead is Equal to Up to 1/4 Circle - **PENALTY 1 POINT**

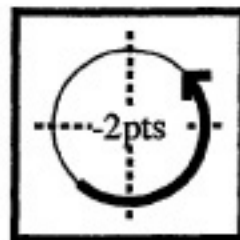

Although This Diagram Indicates a Horse Out of Lead in Three Different Quarters of the Circle, the Distance Traveled Out of Lead is Equal to Up to 1/2 Circle - **PENALTY 2 POINTS**

REINING HORSE DIAGRAMS

Out of Lead Penalties IIb

In patterns where a $\frac{3}{4}$ circle precedes a run, stop, and rollback can be penalized a maximum of **3 POINTS**.

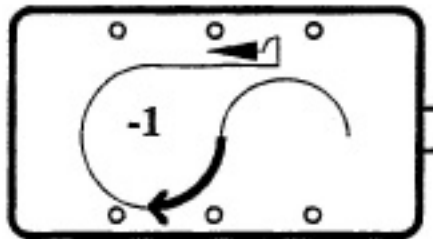
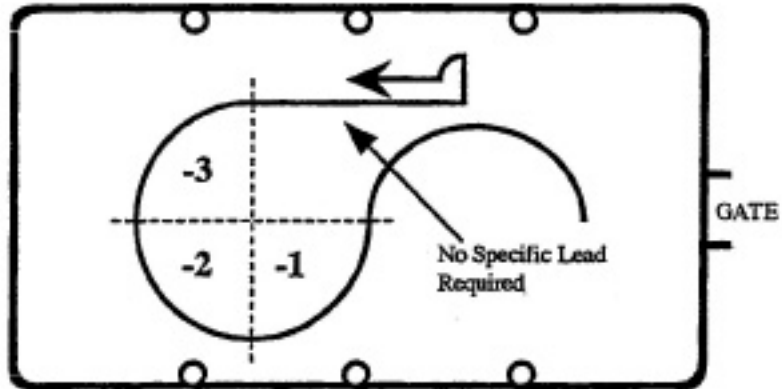

1/4 Circle - 1 POINT PENALTY

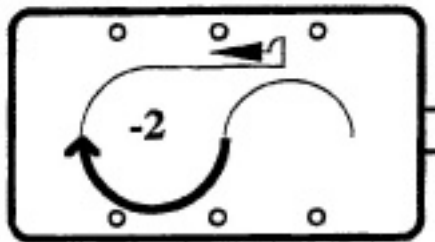

1/2 Circle - 2 POINT PENALTY

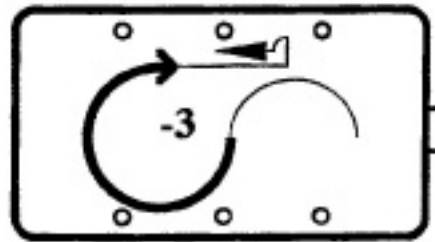

3/4 Circle - 3 POINT PENALTY

REINING HORSE DIAGRAMS

Out of Lead Penalties IIc

In patterns with a centerpiece the correct penalty assessment for being out of lead when a $\frac{3}{4}$ circle and a $\frac{1}{4}$ circle precede a run, stop and rollback is as follows:

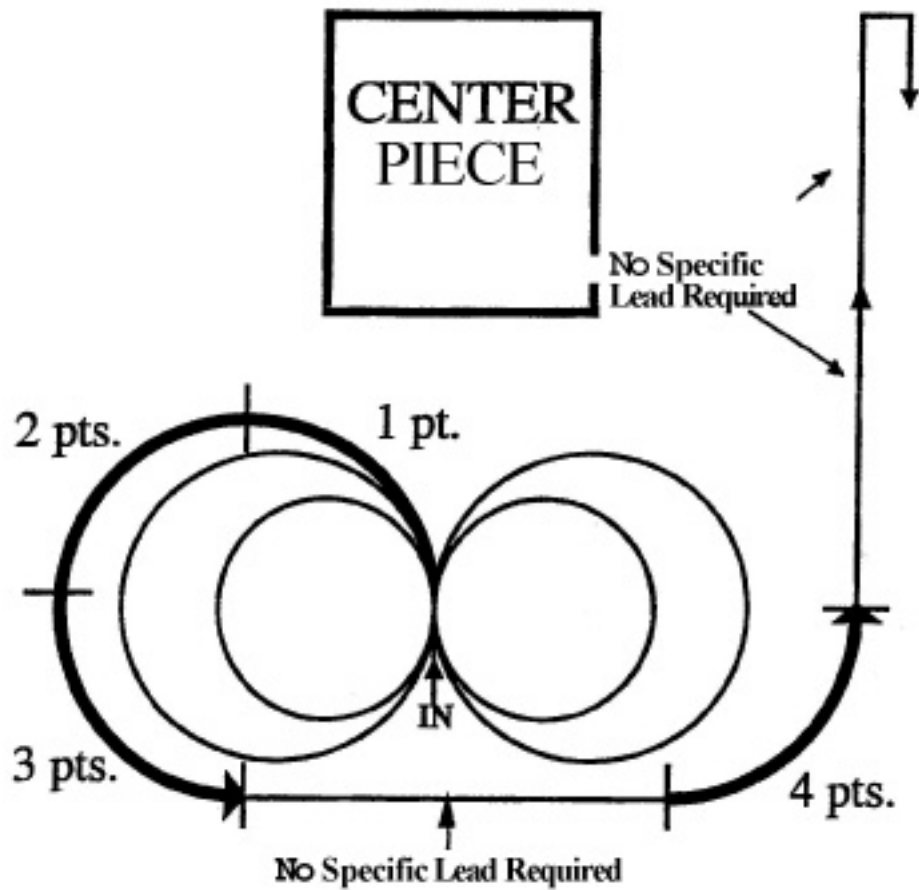

REINING HORSE DIAGRAMS

Out of Lead Penalties III

In patterns requiring a run-around, failure to be on the correct lead when rounding the end of the arena will be penalized as follows:

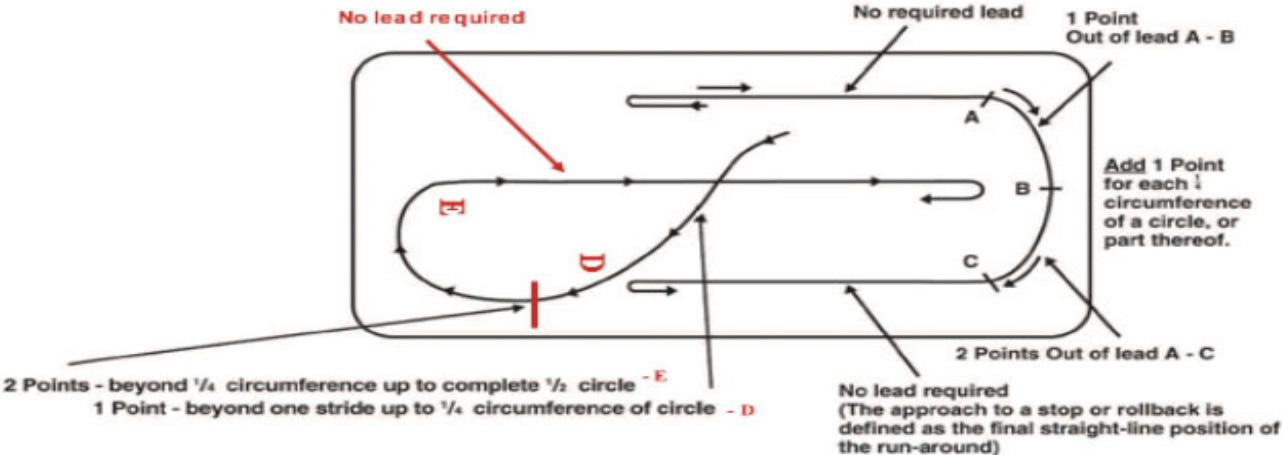

REINING HORSE DIAGRAMS

Out of Lead Penalties IVa

Where a change of lead is specified immediately prior to a half circle followed by a run to the end of the arena, failure to change leads will be penalized as follows:

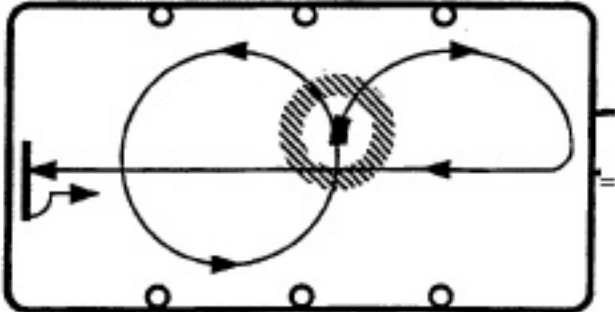

A. Failure to change leads by one stride-
1/2 POINT PENALTY
(See Page 18)

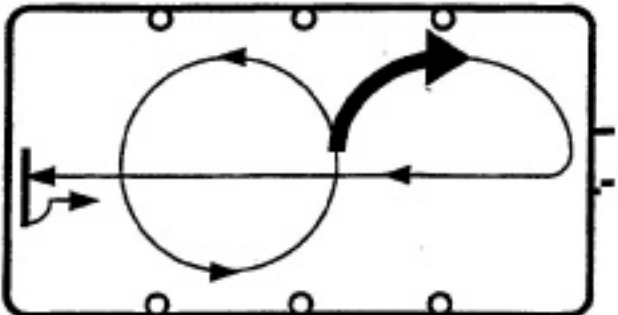

B. Failure to change leads beyond one stride and up to 1/4 of a circle-
1 POINT PENALTY

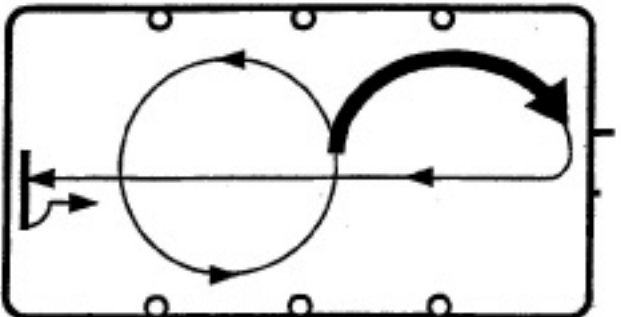

C. Failure to change beyond 1/4 of a circle-
2 POINT PENALTY

REINING HORSE DIAGRAMS

Out of Lead Penalties V

Each time a horse is out of lead, a judge is required to penalize 1 POINT for each ¼ circle or part of traveled.

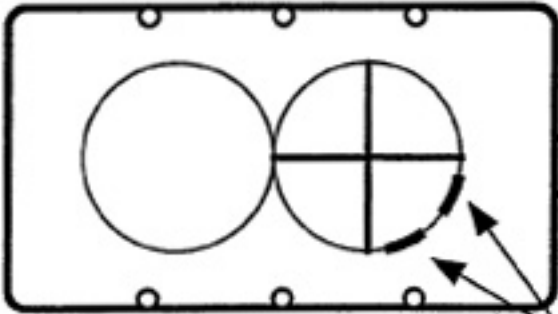

Example A

EXAMPLE A -
Although the distance traveled is less than 1/4 circle, the diagram indicates the horse was out of lead twice in that quarter.
TWO 1 POINT PENALTIES.

Out of Lead Twice

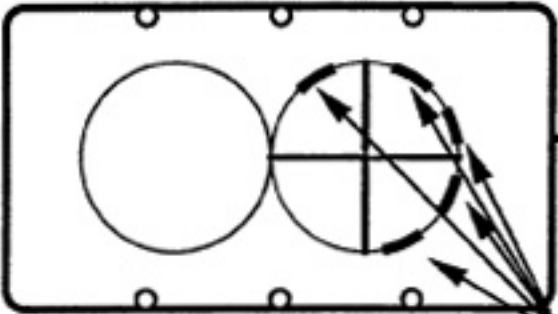

Example B

EXAMPLE B -
Although the distance traveled is less than 3/4 circle, the diagram indicates the horse was out of lead five times in that circle.
FIVE 1 POINT PENALTIES.

Out of Lead 5 Times

REINING HORSE DIAGRAMS

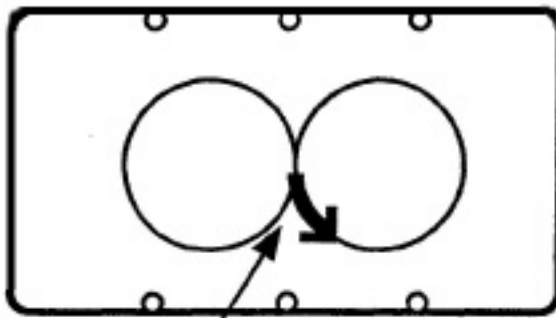

When starting a circle, jogging up to 2 strides results in a 1/2 POINT PENALTY.

Jogging Up to 2 Strides

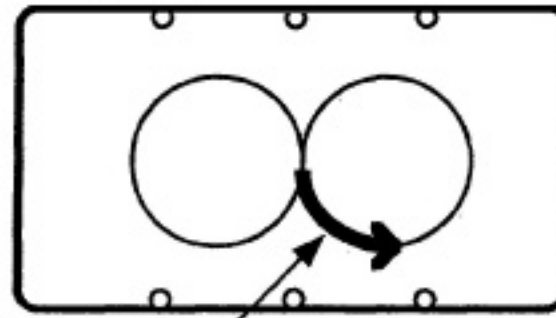

When starting a circle, jogging more than 2 strides, but less than 1/2 the circumference of the circle results in a 2 POINT PENALTY.

Jogging More Than 2 Strides, but Less Than 1/2 the Circumference of the Circle

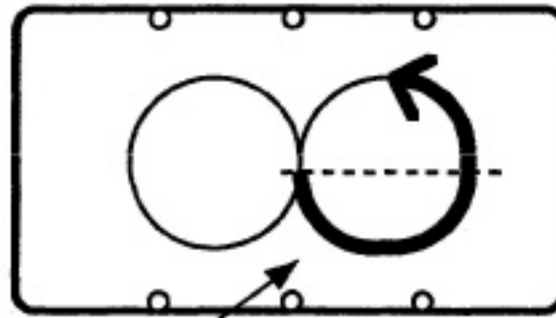

Jogging in excess of 1/2 a circle results in a ZERO SCORE

Jogging More Than 1/2 the Circumference of the Circle

REINING HORSE DIAGRAMS

Jogging Penalties II

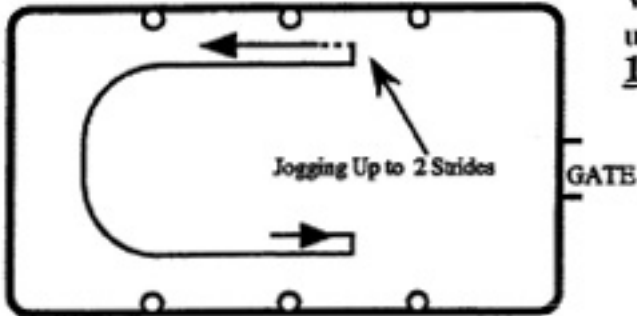

When exiting a rollback, jogging up to 2 strides results in a 1/2 POINT PENALTY.

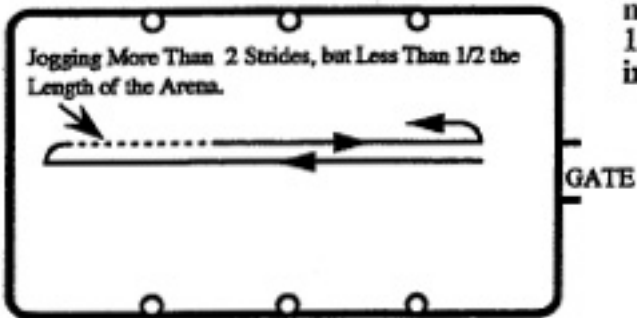

When exiting a rollback, jogging more than 2 strides, but less than 1/2 the length of the arena results in a 2 POINT PENALTY.

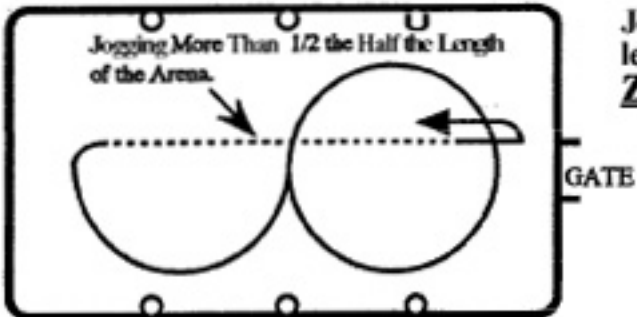

Jogging in excess of 1/2 the length of the arena results in a ZERO SCORE

REINING HORSE DIAGRAMS

Spin Penalties I

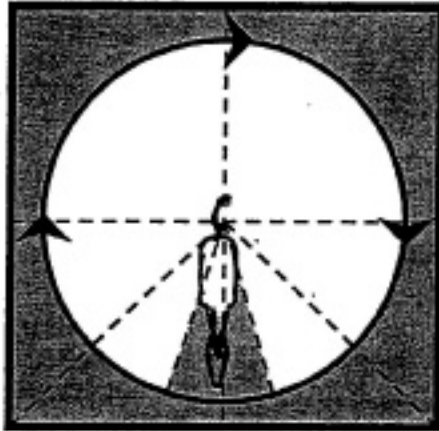

Optimum position at conclusion of spins.

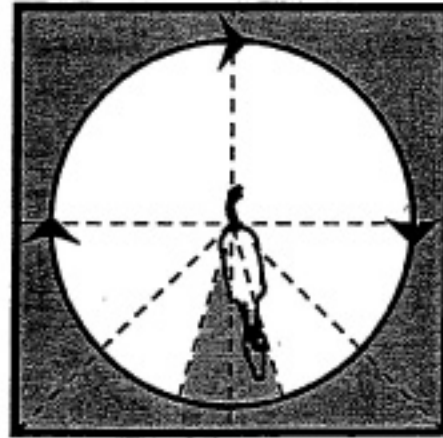
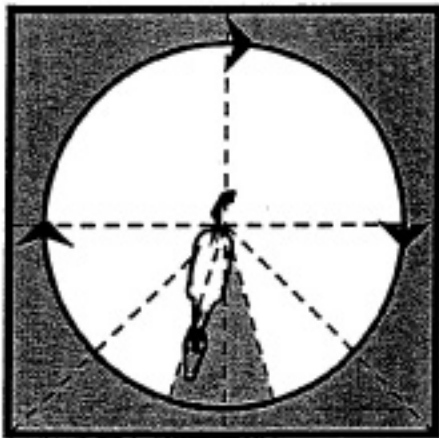

A shoulder's width either side of center line - NO PENALTY.
(Horse's shoulder must be touching line)

REINING HORSE DIAGRAMS

Spin Penalties II

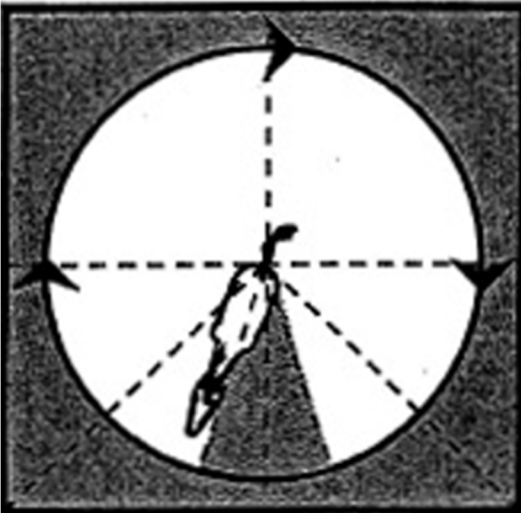

Horse has overspun enough that the shoulder is not touching the center line.
1/2 POINT PENALTY

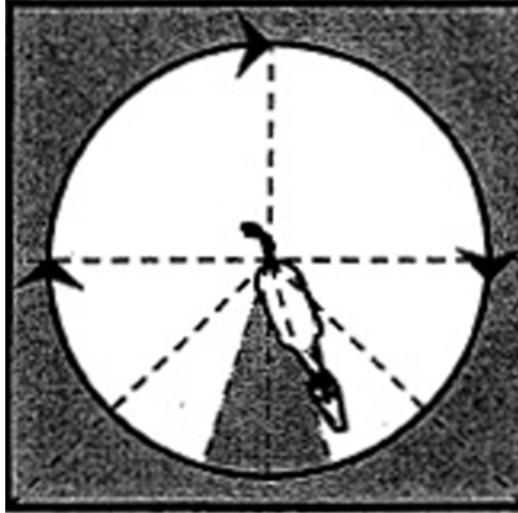

Horse has underspun enough that the shoulder is not touching the center line.
1/2 POINT PENALTY

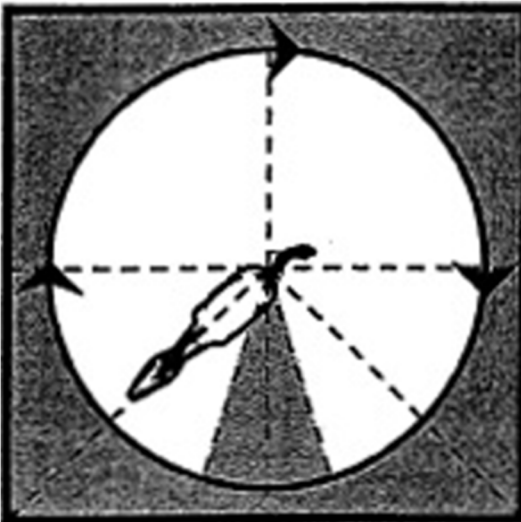

Horse has overspun a **full 1/8** of a turn.
1/2 POINT PENALTY

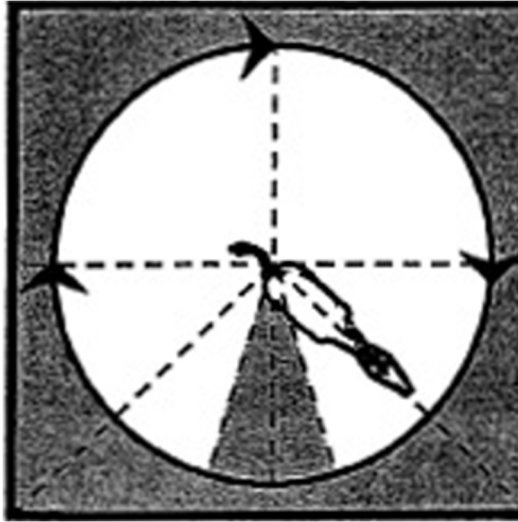

Horse has underspun a **full 1/8** of a turn.
1/2 POINT PENALTY

REINING HORSE DIAGRAMS

Spin Penalties III

OVER/UNDER SPINS OF UP TO 1/4 OF A TURN

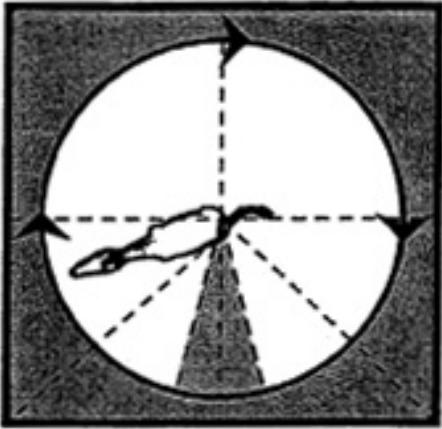

The above horse has overspun more than 1/8 of a turn. 1 POINT PENALTY

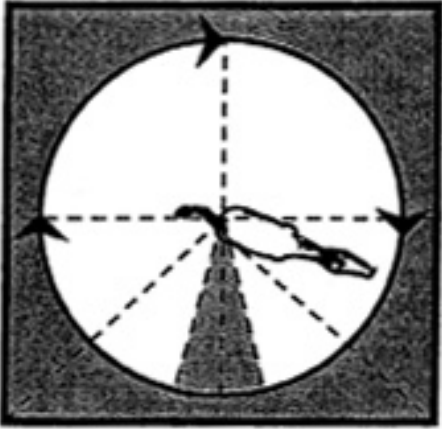

The above horse has underspun more than 1/8 of a turn. 1 POINT PENALTY

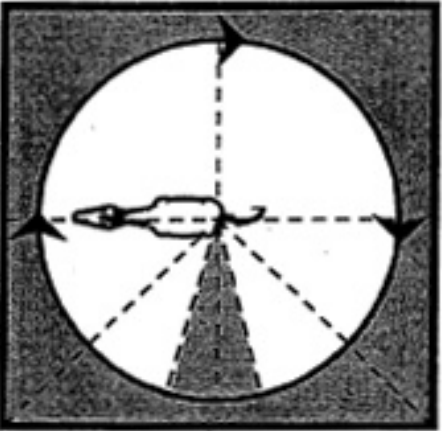

The above horse has overspun 1/4 of a turn. 1 POINT PENALTY

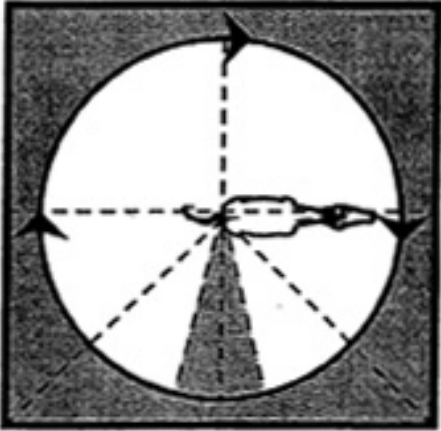

The above horse has underspun 1/4 of a turn. 1 POINT PENALTY

REINING HORSE DIAGRAMS

Spin Penalties IV

OVER/UNDER SPINS OF OVER 1/4 OF A TURN

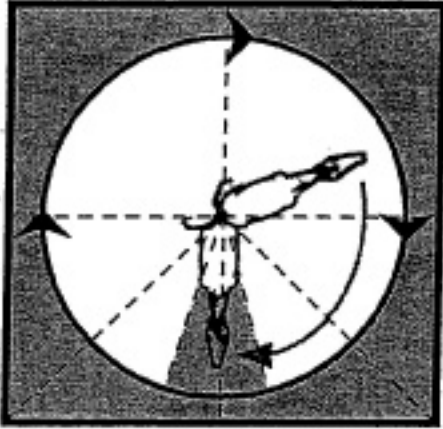

The above horse has underspun more than a 1/4 turn and then restarts and completes maneuver. **2 POINT FREEZE UP PENALTY**

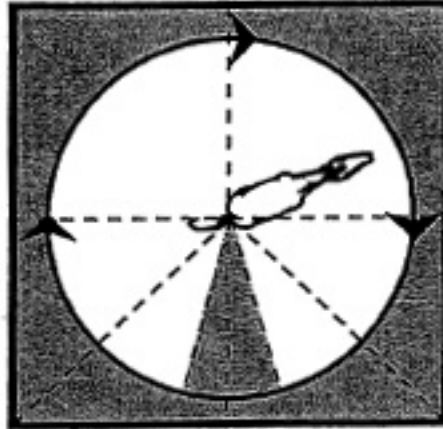

The above horse has underspun more than a 1/4 turn and does not complete maneuver. **ZERO SCORE**

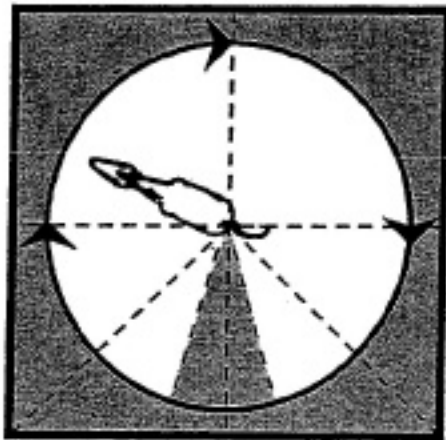

← The horse to the left has overspun more than a 1/4 turn. **ZERO SCORE**

REINING HORSE DIAGRAMS

Spin Penalties V

FREEZE UPS

Freezing up in a spin or rollback will result in a **2 POINT PENALTY**

FREEZE UP: Any brief but obvious refusal to start a spin or rollback or any complete stoppage of a horse's lateral shoulder movement that delays the execution of the spin or rollback.



When applied to spins, the freeze-up penalty warranted for an under spin of more than $\frac{1}{4}$ of the circumference of the circle.

REINING HORSE DIAGRAMS

Break of Gait

Any time a horse breaks gait during execution of the pattern, a 2 POINT PENALTY will apply.

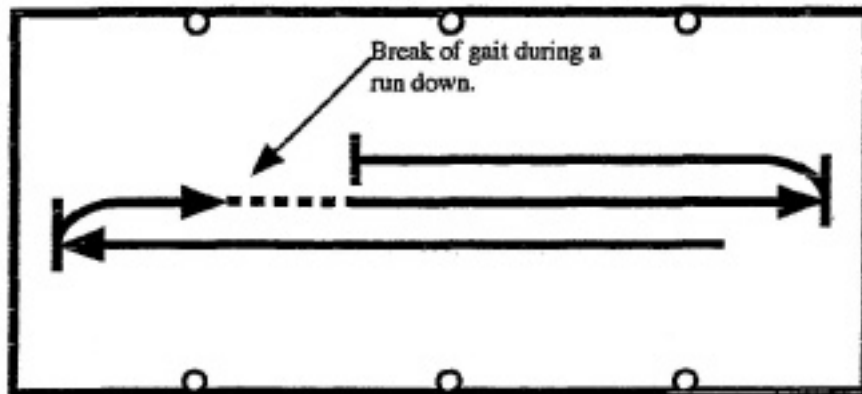

Break of gait. 2 POINT PENALTY

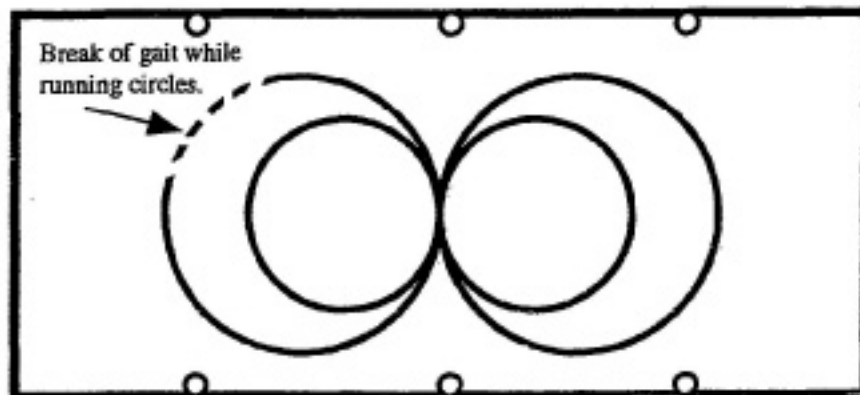

Break of gait. 2 POINT PENALTY

REINING HORSE DIAGRAMS

Break of Gait

Stopping in the first 1/4 circumference of a circle after a canter departure is NOT to be considered an inclusion of a maneuver, rather a 2 POINT break of gait penalty shall apply.

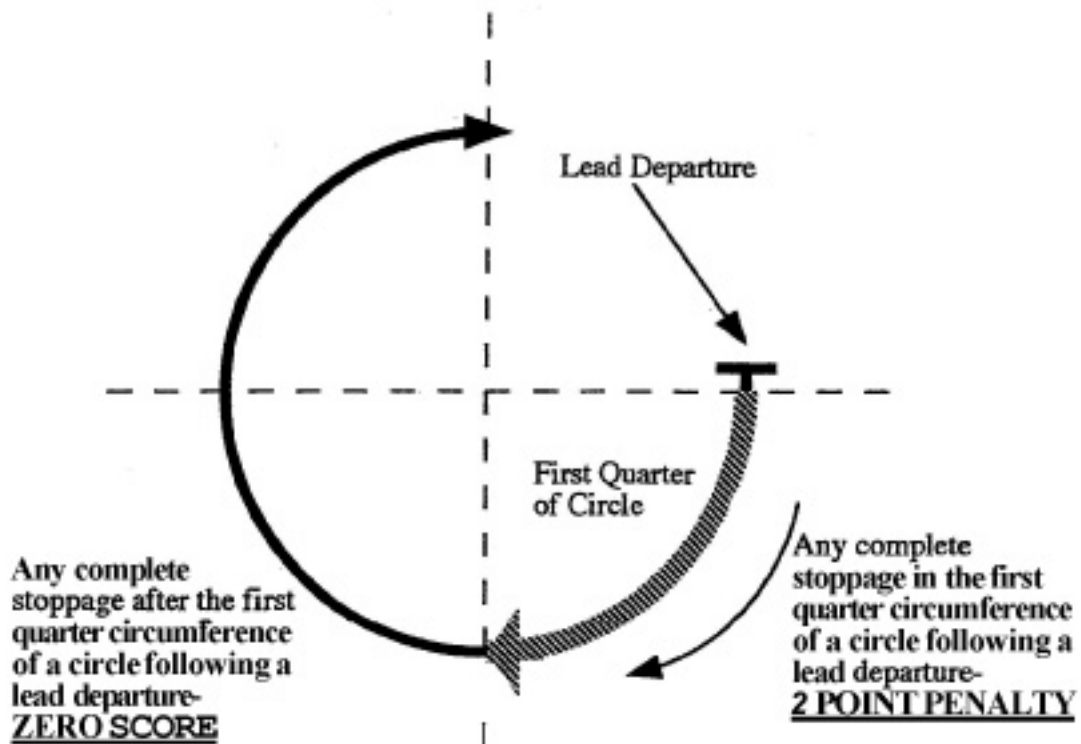

REINING HORSE DIAGRAMS

Run Down Penalty

In patterns that require the horse to run around the end of the arena it is specified the horse must remain a minimum of 20 feet from the wall or fence when approaching a stop and/or rollback. Failure to do so will result in a 1/2 POINT PENALTY.

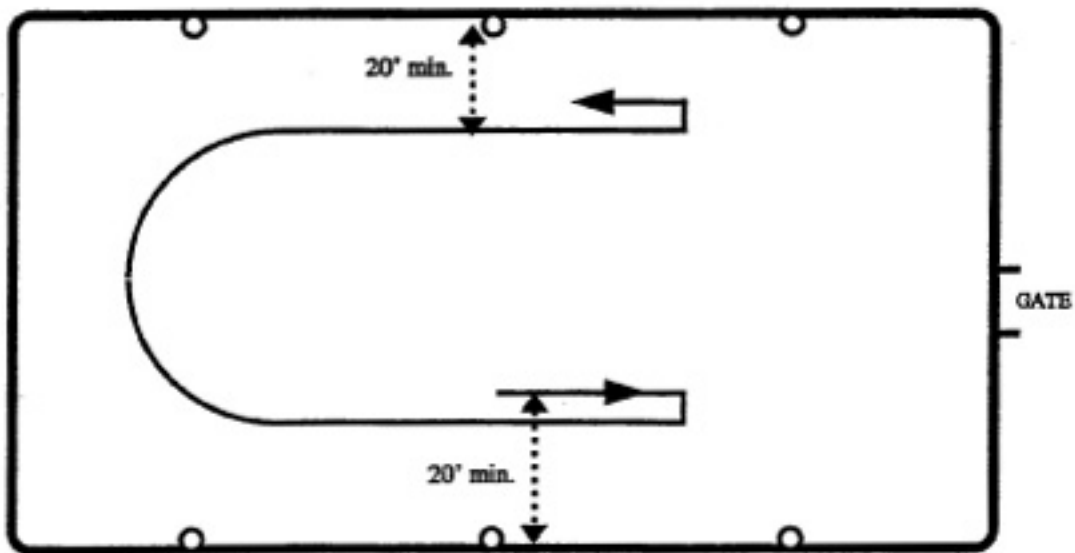

REINING HORSE DIAGRAMS

Marker Penalties

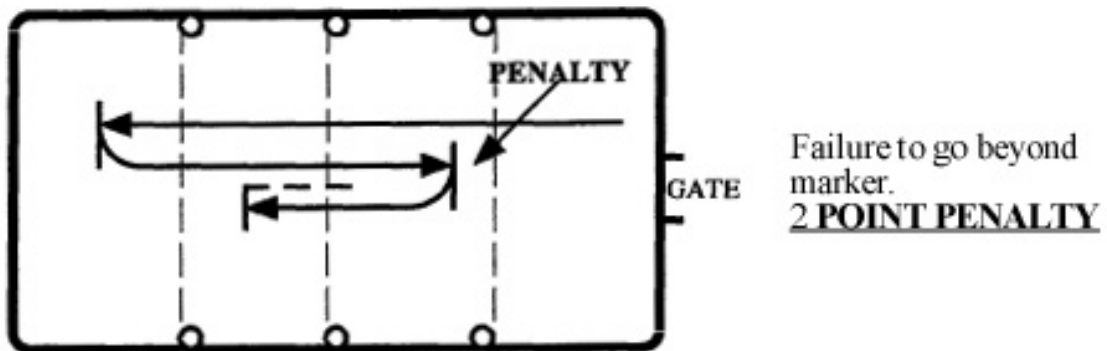
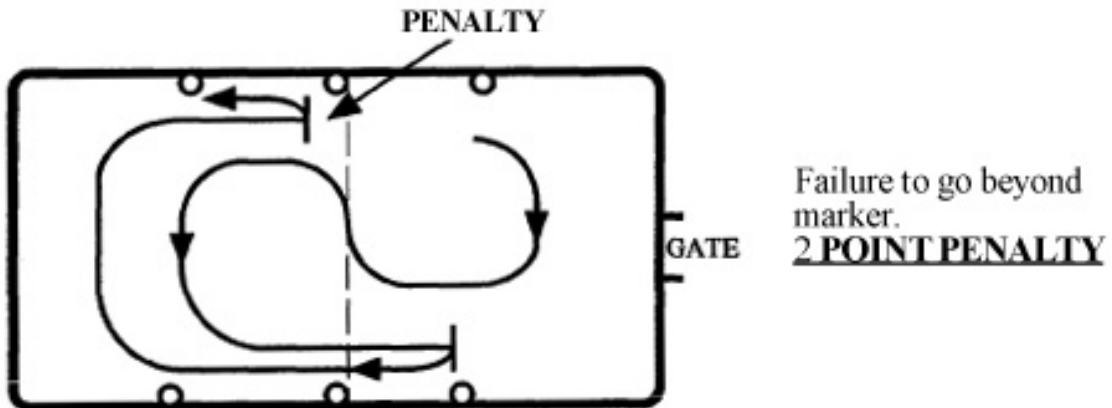

SEE ADDITIONAL DIAGRAMS IN
THE NRHA HANDBOOK – JUDGE’S GUIDE SECTION

Access the most current score sheets & notes from the AHA website:
<https://www.arabianhorses.org/judges-stewards/patterns/>



SHOW _____

DATE: _____

CLASS NO: _____

Class Title: _____

PATTERN

Maneuver
Description

NO. _____

Maneuver 1 2 3 4 5 6 7 8

Draw	Entry #	Penalty									Penalties	SCORE
		Score										
		Sub T										
		Score										
		Sub T										
		Score										
		Sub T										
		Score										
		Sub T										
		Score										
		Sub T										
		Score										
		Sub T										
		Score										
		Sub T										
		Score										
		Sub T										
		Score										
		Sub T										
		Score										
		Sub T										
		Score										
		Sub T										

Judges Signature _____ Page# _____ of _____

Reining Self-Test Practice on Penalties

Abuse of animal _____

Equipment failure that delays pattern _____

Over/under spin up to 1/8 turn _____

Blatant disobedience _____

Failure to remain a minimum of 20' from side of arena
when approaching stop or rollback _____

Failure to complete pattern as written/
performing maneuvers out of order _____

Break of gait _____

Using romal with finger(s) between reins _____

Walk in pattern: failure to stop or walk
prior to lope departure or loping
prior to reaching center of arena _____

Use of either hand to instill fear or praise _____

Holding saddle with either hand _____

Out of lead each 1/4 circle or part of _____

Use of illegal equipment _____

Over/Under Spin up to 1/4 _____

Failure to completely pass specified marker before
initiating stop position _____

Jogging beyond 2 strides but less than
1/2 circle or 1/2 length of arena _____

Balking or refusal that delays pattern _____

Not providing horse for inspection _____

Backing more than 2 strides when not
called for in pattern _____

Spurring in front of cinch _____

Running away or failure to guide where
you cannot tell if he is on pattern _____

On run in pattern failure to be at lope
or break of gait prior to 1st marker _____

Delayed change of lead by 1 stride when
lead change required in pattern _____

Disrespect by exhibitor _____

Turn of 90 Degrees when not called for _____

Use of two hands or changing hands _____

Freezing up in spins or rollback _____

Fall to ground by horse or rider _____

Over spin beyond 1/4 _____

Dropping rein that contacts ground while
horse in motion _____

Jogging more than 1/2 circle or 1/2 length of arena while starting
circle, circling or exiting roll back _____

Jogging up to 2 strides when
beginning circle or exiting rollback _____

Use of any attachment which alters
movement or circulation of tail _____

Use of more than index or first finger
between reins _____

Complete stop before 1st marker in
run in pattern _____

Failure to be on correct lead for 1/2 turn or less when rounding
end of arena for run-around _____

Failure to be on correct lead for more than 1/2 turn when
rounding end of arena for run-around _____

Failure to wear appropriate WS attire _____

Act of a horse dropping to knees or hocks _____

Use of bellyband or belly wrap _____

Abuse of animal _____

Equipment failure that delays pattern _____

Over/under spin up to 1/8 turn _____

Blatant disobedience _____

Failure to remain a minimum of 20' from side of arena
when approaching stop or rollback _____

Failure to complete pattern as written/
performing maneuvers out of order _____

Break of gait _____

Using romal with finger(s) between reins _____

Walk in pattern: failure to stop or walk
prior to lope departure or loping
prior to reaching center of arena _____

Use of either hand to instill fear or praise _____

Holding saddle with either hand _____

Out of lead each 1/4 circle or part of _____

Use of illegal equipment _____

Over/Under Spin up to 1/4 _____

Failure to completely pass specified marker before
initiating stop position _____

Jogging beyond 2 strides but less than
1/2 circle or 1/2 length of arena _____

Balking or refusal that delays pattern _____

Not providing horse for inspection _____

Backing more than 2 strides when not
called for in pattern _____

Spurring in front of cinch _____

Running away or failure to guide where
you cannot tell if he is on pattern _____

On run in pattern failure to be at lope
or break of gait prior to 1st marker _____

Delayed change of lead by 1 stride when
lead change required in pattern _____

Disrespect by exhibitor _____

Turn of 90 Degrees when not called for _____

Use of two hands or changing hands _____

Freezing up in spins or rollback _____

Fall to ground by horse or rider _____

Over spin beyond 1/4 _____

Dropping rein that contacts ground while
horse in motion _____

Jogging more than 1/2 circle or 1/2 length of arena while starting
circle, circling or exiting roll back _____

Jogging up to 2 strides when
beginning circle or exiting rollback _____

Use of any attachment which alters
movement or circulation of tail _____

Use of more than index or first finger
between reins _____

Complete stop before 1st marker in
run in pattern _____

Failure to be on correct lead for 1/2 turn or less when rounding
end of arena for run-around _____

Failure to be on correct lead for more than 1/2 turn when
rounding end of arena for run-around _____

Failure to wear appropriate WS attire _____

Act of a horse dropping to knees or hocks _____

Use of bellyband or belly wrap _____

Prepared by the

Education & Evaluation Commission and the
Judges & Stewards Commissioner
6030 Greenwood Plaza Blvd, Suite 100
Greenwood Village, CO 80111
303-696-4539